

# Creare

Modern Design Furniture  
to Create Space

Sofa & Bench / Chair / Outdoor



Creare

Modern Design  
Furniture  
to Create Space.



# Index

Sofa  
&  
Bench



**DIDOT**  
P14



**DIDOT**  
P16



**DIDOT**  
P18



**DIDOT**  
P18



**DIDOT**  
P18



**DIDOT**  
P19



**DIDOT**  
P19



**DIDOT**  
P19



**DIDOT**  
P19



**YVES**  
P20



**YVES**  
P20



**YVES**  
P20



**YVES**  
P20



**YVES**  
P20



**YVES**  
P20



**YVES**  
P20



**YVES**  
P22



**EMILY**  
P24



**EMILY**  
P24



**EMILY**  
P24



**EMILY**  
P26



**EMILY**  
P26



**EMILY**  
P26



**C-1**  
P28



**C-1**  
P28



**C-1**  
P28



**C-1**  
P28



**C-1**  
P28



**C-1**  
P28



R-2  
P32



R-2  
P33



The Frame  
P34



The Frame  
P34



The Frame  
P34



The Frame  
P34



The Frame  
P36



ENKO  
P38



ENKO  
P38



ENKO  
P38



ENKO  
P38



oalt  
P40



oalt hold  
P42



uask  
P44



SCOOP  
P46



SCOOP  
P46



SCOOP  
P46



SCOOP  
P48



SCOOP  
P48



SCOOP  
P48



SCOOP  
P48



SCOOP  
P48



RING  
P50



nuts  
P52



SVEVO  
P54



AURA  
P56



AURA  
P56



ANTEPRIMA  
P58



VIAGGIO  
P59



DON GIOVANNI  
P60



**DOLLY**  
P61



**CAMMEO**  
P62



**LOUNGER**  
P64



**LOUNGER**  
P64



**HAMPER**  
P66



**HAMPER**  
P66



**MAGNUM**  
P68



**MAGNUM**  
P70



**MAGNUM**  
P70



**TORTUGA**  
P72



**TALO**  
P74



**TALO**  
P74



**NIDO**  
P76



**ELEPHANT**  
P78

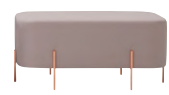

**ELEPHANT**  
P78

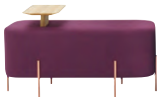

**ELEPHANT**  
P78



**KONOHA**  
P80



**COSTURA**  
P82



**COSTURA**  
P82



**COSTURA**  
P82



**COSTURA**  
P82



**NUBE**  
P84



**TK-1**  
P86



**TK-1**  
P86



**TK-1**  
P86



**COLINA**  
P88



**CATIFA80**  
P90



**CATIFA80**  
P90



**ZINTA**  
P92



**PLUS**  
P94





**ADD**  
P96



**ADD**  
P96



**ADD**  
P96



**ADD**  
P96



**ADD**  
P96



**BILDU**  
P98



**SLAM**  
P99



**SLAM**  
P99



**DNA**  
P100



**DNA**  
P100



**DIDOT**  
P104



**DIDOT**  
P104



**DIDOT**  
P104



**EMILY**  
P106



**EMILY**  
P106



**EMILY**  
P106



**R-2**  
P108



**R-2**  
P109



**The Frame**  
P110



**SHOWTIME**  
P112



**SHOWTIME**  
P112



**SUITE**  
P114



**STRIKE**  
P116



**STRIKE**  
P116



**STRIKE**  
P116



**STRIKE**  
P116



**BACI**  
P118



**BASICWOOD**  
P120



**BASICWOOD**  
P120



**KITE**  
P122



**KITE**  
P122



**ALBA**  
P124



**ALBA**  
P124



**ALBA**  
P124



**AURA**  
P126



**AURA**  
P126



**AURA**  
P126



**MUSA**  
P128



**MUSA**  
P128



**MUSA**  
P128



**MUSA**  
P128



**MOON LIGHT**  
P130



**MOON LIGHT**  
P130



**ARO**  
P132



**CF CHAIR**  
P134



**CF CHAIR**  
P134



**RU CHAIR**  
P136



**RU CHAIR**  
P136



**FRAME**  
P138



**FRAME**  
P138



**FRAME**  
P138



**FRAME**  
P138



**LACLASICA**  
P140



**MIXIS**  
P142



**MIXIS**  
P142



**MIXIS AIR**  
P144



**MIXIS AIR**  
P144



**POLA LIGHT**  
P146



**POLA LIGHT**  
P146



**POLA LIGHT**  
P146



**NETT**  
P148



**NETT**  
P148



**POLA ROUND**  
P149



**POLA ROUND**  
P149



**KAY**  
P150



**KABIRA**  
P152



**KABIRA**  
P152



**KABIRA**  
P152



**MÁNI**  
P154



**MÁNI**  
P154



**MÁNI**  
P154



**VERVE**  
P156



**VERVE**  
P156



**VERVE**  
P156



**VERVE**  
P156



**ACME**  
P158



**ACME**  
P158



**ACME**  
P158



**ACME**  
P158



**GILA**  
P160



**CILA**  
P160



**CILA**  
P160



**CATIFA 46**  
P162



**SLIM**  
P164



**MASTER**  
P166



**MASTER**  
P166



**A-COLLECTION**  
P168



**A-COLLECTION**  
P168



**A-COLLECTION**  
P168



**A-COLLECTION**  
P168



**GAS**  
P170



**GAS**  
P170



**GAS**  
P170



**GLOBUS**  
P172



**SAT**  
P174



**SIGN**  
P176



**SIGN**  
P176



**SIGN**  
P176



**SIGN**  
P176



**BT STOOL**  
P178



**ARO**  
P180



**APELLE JUMP**  
P182



**APELLE JUMP**  
P182



**BARBRY**  
P184



**JAMAICA STOOL**  
P186



**ONDA**  
P188



**ONDA**  
P188

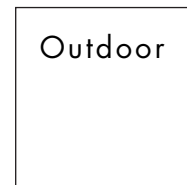

**OBI**  
P192



**OBI**  
P192



**OBI**  
P192



**BOLD**  
P194



**BOLD**  
P194



**BOLD**  
P194



**LAPALA**  
P196



**LAPALA**  
P196



**CLEVER**  
P198



**LEAF**  
P200



**LEAF**  
P200



**LEAF**  
P202



**LEAF**  
P202



**JUNO**  
P204



**JUNO**  
P204



**JUNO**  
P204

---



**JUNO**  
P204

---



Sofa & Bench



# DIDOT

*Creare*







**DIDOT**

*Creare*





C-SF-A082-SF1



C-SF-A082-SF5



C-SF-A082-SF3



C-SF-A082-SF2  
(背合わせ両面タイプ)

# DIDOT

Creare



C-SF-A082-SF4



C-SF-A081-AC



C-CW-A080-AC1



C-CW-A080-AC2



C-CW-A080-ST

Price list \_ P.208





C-SF-A083-AC1



C-SF-A083-SF



C-SF-A083-ROA



C-SF-A083-RAK



C-SF-A083-SCK



C-SF-A083-B2-A



C-SF-A083-B2-B

# YVES

Creare

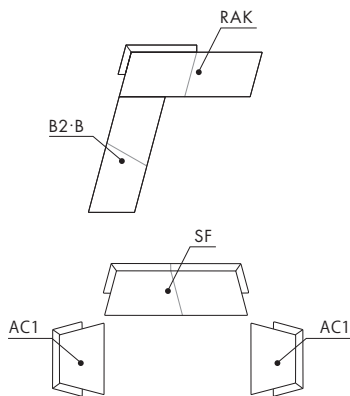







C-TL-A083

# YVES

*Creare*



# EMILY

*Creare*



C-SF-A086-AC

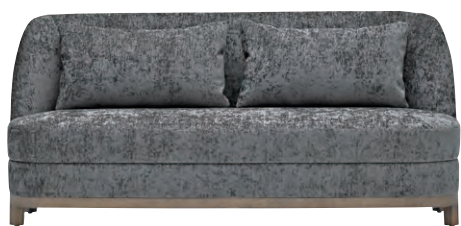

C-SF-A086-LC



C-SF-A086-SF





C-CW-CY-030



C-CW-CY-040



C-CW-CY-050

# EMILY

*Creare*



C-SF-CY-062/C-SF-CY-063

# C-1

*Creare*



テーブル:C-TT-CY-065



# C-1

*Creare*





C-SF-CY-060



C-SF-CY-061



C-SF-CY-062



C-SF-CY-063



C-SF-CY-064



テーブル:C-TT-CY-065



**R-2**

*Creare*



C-CW-CY-010

Price list \_ P.209



# R-2

*Creare*



C-CW-CY-020

Price list \_ P.209



# The Frame

*Creare*



C-SF-A089-OT



C-SF-A089-S1



C-SF-A089-S2



C-SF-A089-S3  
クッション: C-SF-A089-KC





C-CS-A079

# The Frame

*Creare*



# ENKO

*Creare*



C-SF-A062-AC





C-SF-A061-AC



C-SF-A061-SF



C-SF-A063-ST

Price list \_ P.209





BK

C-SF-A069-□

# oalt

Creare

Wood Color

NA BK  
Natural Black

Price list \_ P.210





C-SF-A070-□

NA

# oalt hold

Creare

Wood Color

- NA Natural
- BK Black

Price list \_ P.210





C-SF-A073

**uask**

*Creare*







C-SF-A077-AC-M



C-SF-A077-S3-M



C-SF-A077-S4-M

# SCOOP

*Creare*



# SCOOP

*Creare*



C-SF-A077-AC



C-SF-A077-S3



C-SF-A077-ST



C-SF-A077-S4



C-SF-A077-AC-KIZ  
for kids



# RING

*Creare*



S-SM-A109







C-SF-A084

**nuts**

*Creare*



# SVEVO

NATUZZI





Sofa & Bench



C-SF-NI-B358-SF

Price list \_ P.210





C-SF-NI-050 □



C-SF-NI-060 □

Color



**AURA**  
NATUZZI



C-SF-NI-110-□

Color



# ANTEPRIMA

NATUZZI

Price list \_ P.210



C-SF-NI-010-V1

Color



Gray

# VIAGGIO

NATUZZI

Price list \_ P.211



2人掛:C-SF-NI-020-S2-D1  
3人掛:C-SF-NI-030-S3-D1

S2

# DON GIOVANNI

NATUZZI



C-SF-NI-040-□

Color



# DOLLY

NATUZZI

Price list \_ P.211



# CAMMEO

NATUZZI





C-SF-NI-120-C1



C-SF-NI-120-C2





NG

C-SF-BD-B321-H-□



FR13

C-SF-BD-B321-L-□

Wood Color

FR13

NG

Ash  
natural

Walnut

# LOUNGER

*Jaime Hayon*



# HAMPER

*Arturo Montanelli Ezio Riva*



C-SF-PE-B345-AC□

A-WA



C-SF-PE-B345-SF□

A-WA

Frame Color

QWO	QNO	AWA	A-NA
White oak	Natural oak	White ash	Natural ash

Price list \_ P.211



# MAGNUM

*Estudihac*



C-SF-SL-B348-55Z

Price list \_ P.211



# MAGNUM

*Estudihac*





C-SF-SL-B348-41



C-SF-SL-B348-47

Price list \_ P.211



# TORTUGA

*Nadadora*



C-SF-SL-B349







C-SF-SL-020-S1  
クッション: C-SF-SL-030-KC



C-SF-SL-021-S1



C-SF-SL-022-S2  
クッション: C-SF-SL-030-KC



# TALO

*Sebastian Herkner*



# NIDO

*Rafa Garcia*



C-SF-SL-030





# ELEPHANT

*Nadadora*





C-SB-SL-060-S1

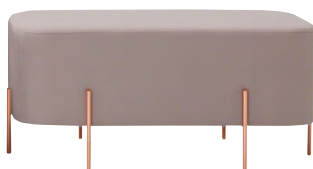

C-SB-SL-070-S2

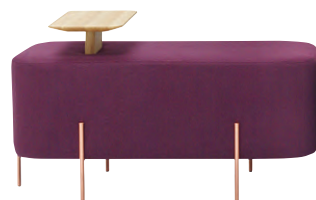

C-SB-SL-080-S2T



# KONOHA

*Toyo Ito*



C-SB-SL-010/C-SB-SL-020/C-SB-SL-030/C-SB-SL-040/C-SB-SL-050



# COSTURA

*Jon Gasca*



C-SF-SA-B361-AC



C-SF-SA-B361-SF



C-SF-SA-B361-OT



C-SF-SA-B361-CL



# NUBE

*Jesus Gasca & Jon Gasca*



C-SF-SA-010



C-SF-SA-011



C-SF-SA-012







C-SB-CE-020



C-SB-CE-021



C-TL-CE-022T



C-TL-CE-030

# TK-1 SOFA

*Creare*



# COLINA

*Lievore Altherr Molina*



※COLINAチェア以外は参考製品です。



C-SF-AR-060

C-SF-AR-030

C-SF-AR-050

C-SF-AR-020

C-SF-AR-040

Price list \_ P.213





C-CS-AR-090



C-CS-AR-100

# CATIFA 80

*Lievore Altherr Molina*



# ZINTA

*Lievore Altherr Molina*



C-SB-AR-020-S3

※クッションは別売りです。 Price list \_ P.213

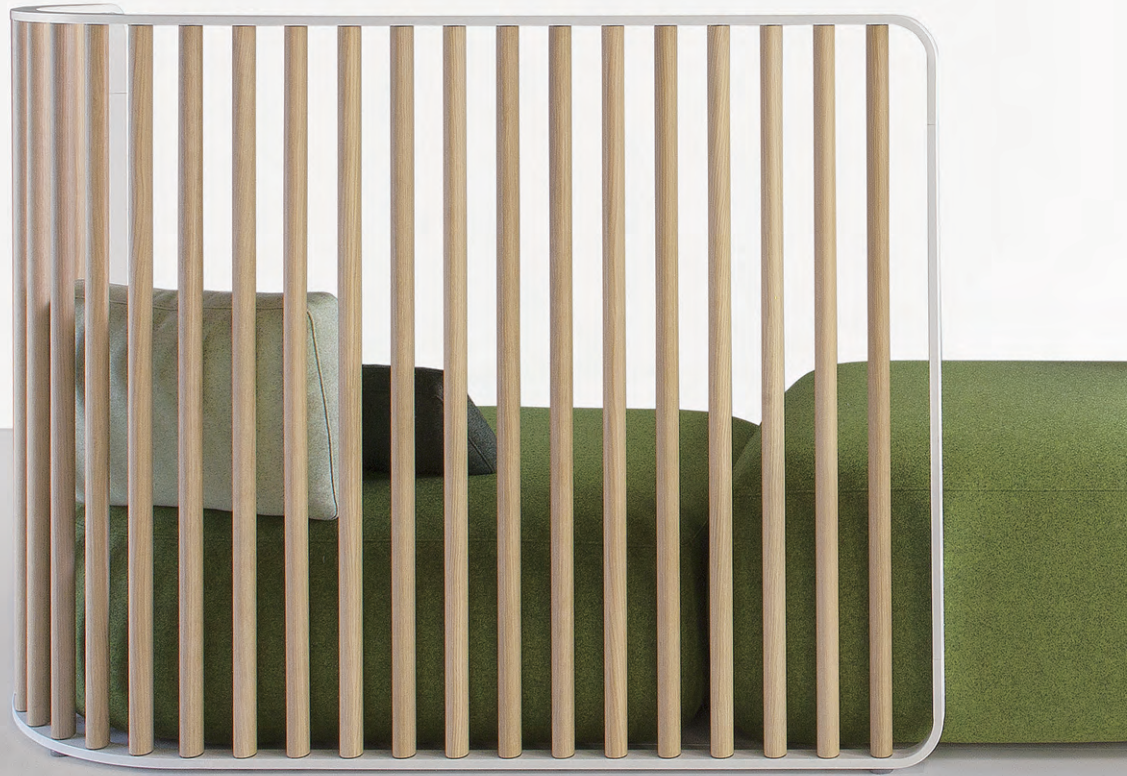

# PLUS

*Francesco Rota*





C-SF-LA-B338 ※テーブルは別売りです。

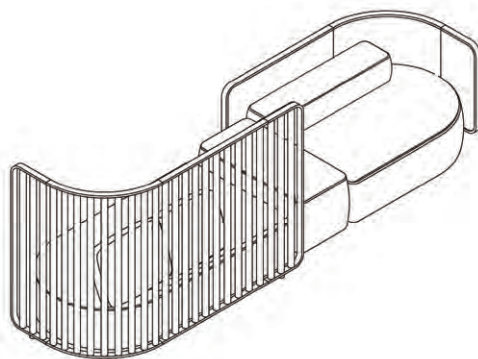

Price list \_ P.213





C-SF-LA-040-S2



C-SF-LA-010-S3



C-TL-LA-020T



C-SB-LA-030



C-SB-LA-070-S5

**ADD**

*Francesco Rota*



C-SB-SX-B359-S4-NA (突板仕様)



C-SB-SX-B359-S4-PVC  
(張り込み仕様)

# BILDU

*Mario Ruiz*



Price list \_ P.214



C-SB-SX-B360-S3A-□

NT



C-SB-SX-B360-S4-□

BP

# SLAM

Lievore Altherr Molina

Color

BP NT  
White Black

Price list \_ P.214

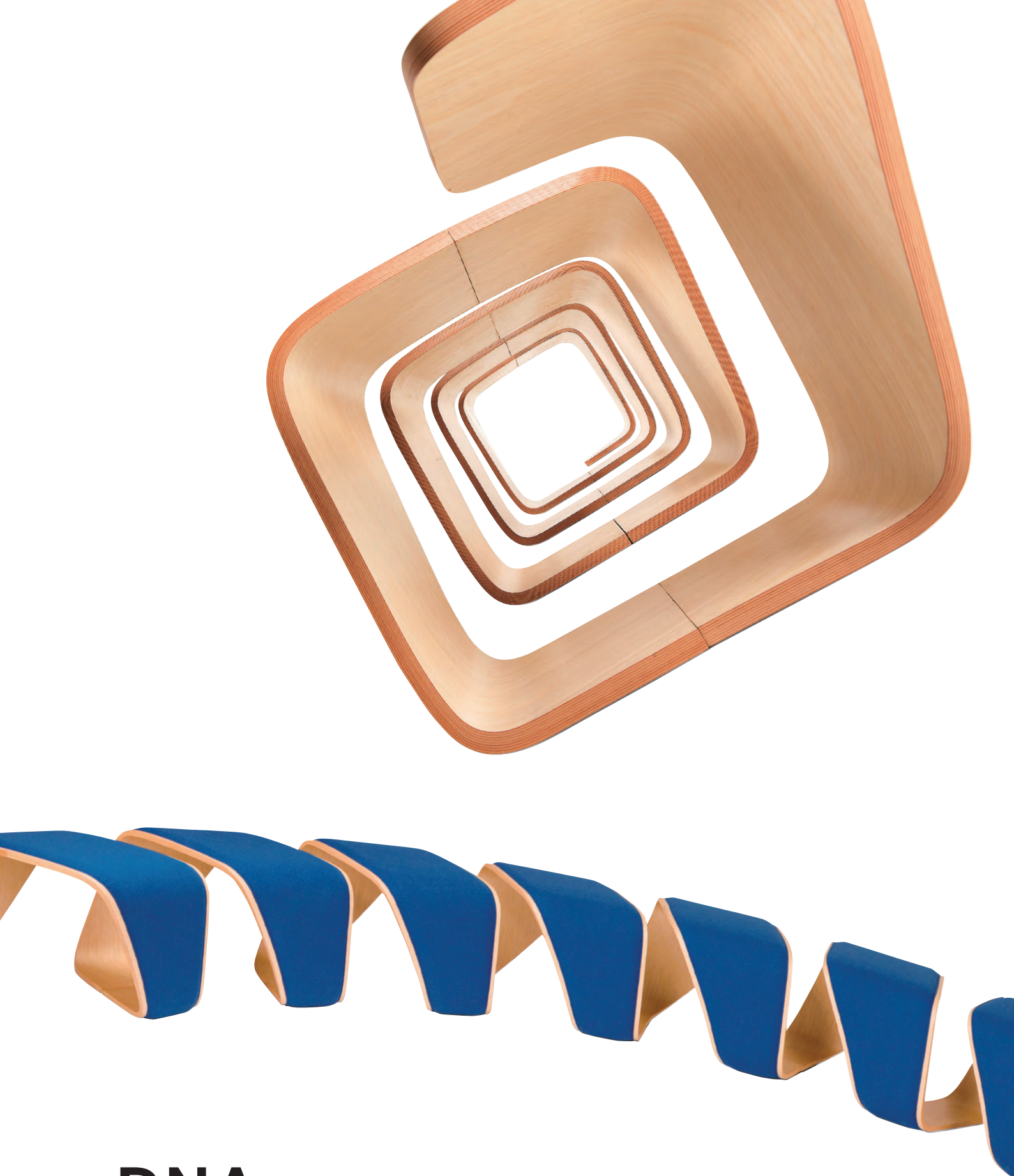

# DNA

*Leonardo Rossano*



C-SB-TE-B355-2T



C-SB-TE-B355-3T



C-SB-TE-B355-3R



C-SB-TE-B355-4R



C-SB-TE-B355-10R





Chair





C-CW-A080-AC1



C-CW-A080-AC2



C-CW-A080-ST

# DIDOT

Creare





C-CW-CY-030



C-CW-CY-040



C-CW-CY-050

Chair

# EMILY

*Creare*



# R-2

*Creare*



C-CW-CY-010

Sofa & Bench \_ P.32    Price list \_ P.209



Chair

# R-2

*Creare*



C-CW-CY-020

Sofa & Bench \_ P.33 Price list \_ P.209







C-CS-A079

# The Frame

*Creare*



# SHOWTIME

*Jaime Hayon*



C-CW-BD-B320-N



C-CW-BD-B320-10/N/09/16/N



C-CW-BD-B320-□

09

- Color
- 10 Black
  - 16 Gray
  - 09 Blue



クッション(ファブリック)  
C-CW-BD-B320-Y02



クッション(レザー)  
C-CW-BD-B320-F18

Price list \_ P.214



# SUITE

*Atelier Nanni*



C-CW-MJ-B341-UTN



C-CW-MJ-B341-K67



# STRIKE

*Atelier Nanni*

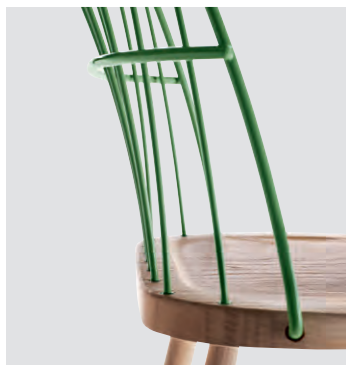

C-CW-MJ-B340-□-S



C-CW-MJ-B340-□-P



C-CW-MJ-B340-□-65  
C-CW-MJ-B340-□-75



C-CW-MJ-B340-□-65P  
C-CW-MJ-B340-□-75P

Steel Color

- SG Sage green
- BK Black

Price list \_ P.214,215







NA

C-CW-PE-B346-□

Chair

# BACI

*Atelier oï*

Wood Color

WO

White  
oak

NA

Natural  
oak

Price list \_ P.215





C-CW-FG-B333-□-AC



C-CW-FG-B333-□-ST

# BASICWOOD

*Christophe Pillet*

Frame Color



Walnut Wenge

Price list \_ P.215



# KITE

*Shin Azumi*

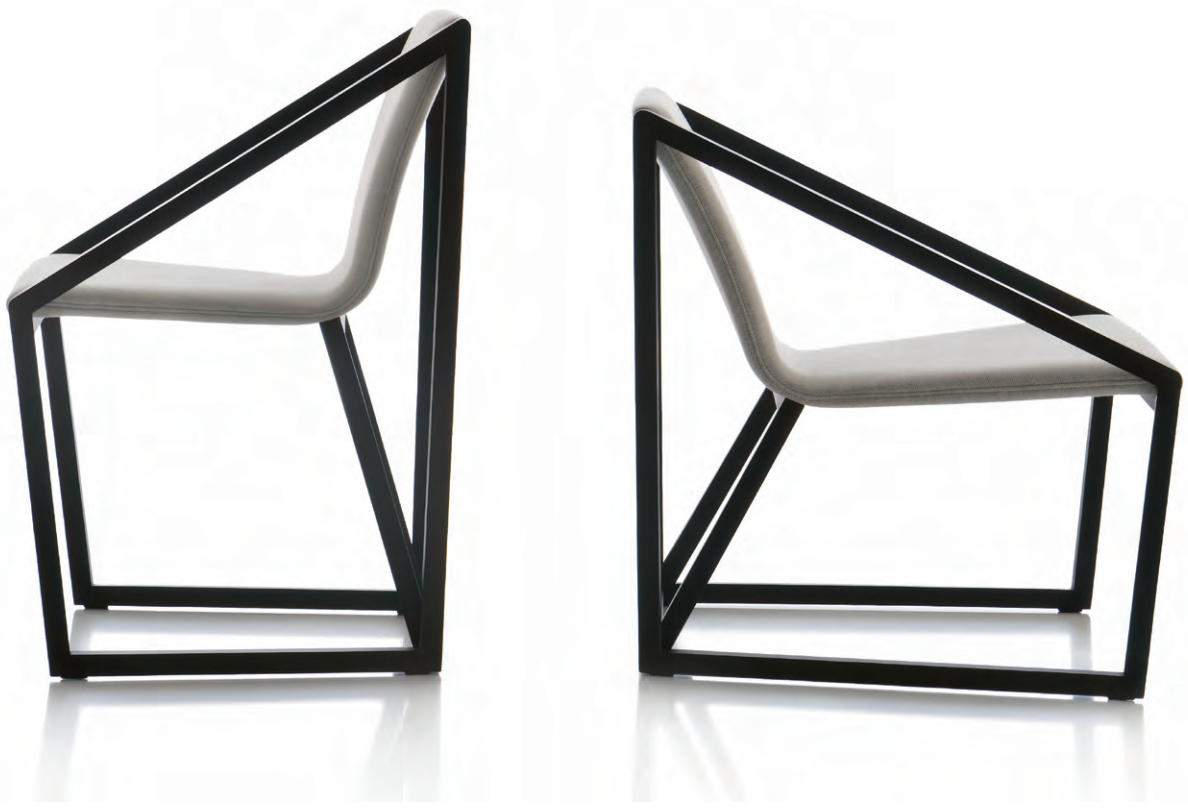

C-CW-FG-B334-□-S



C-CW-FG-B334-□-L

Frame Color

- OAK White oak
- M Walnut

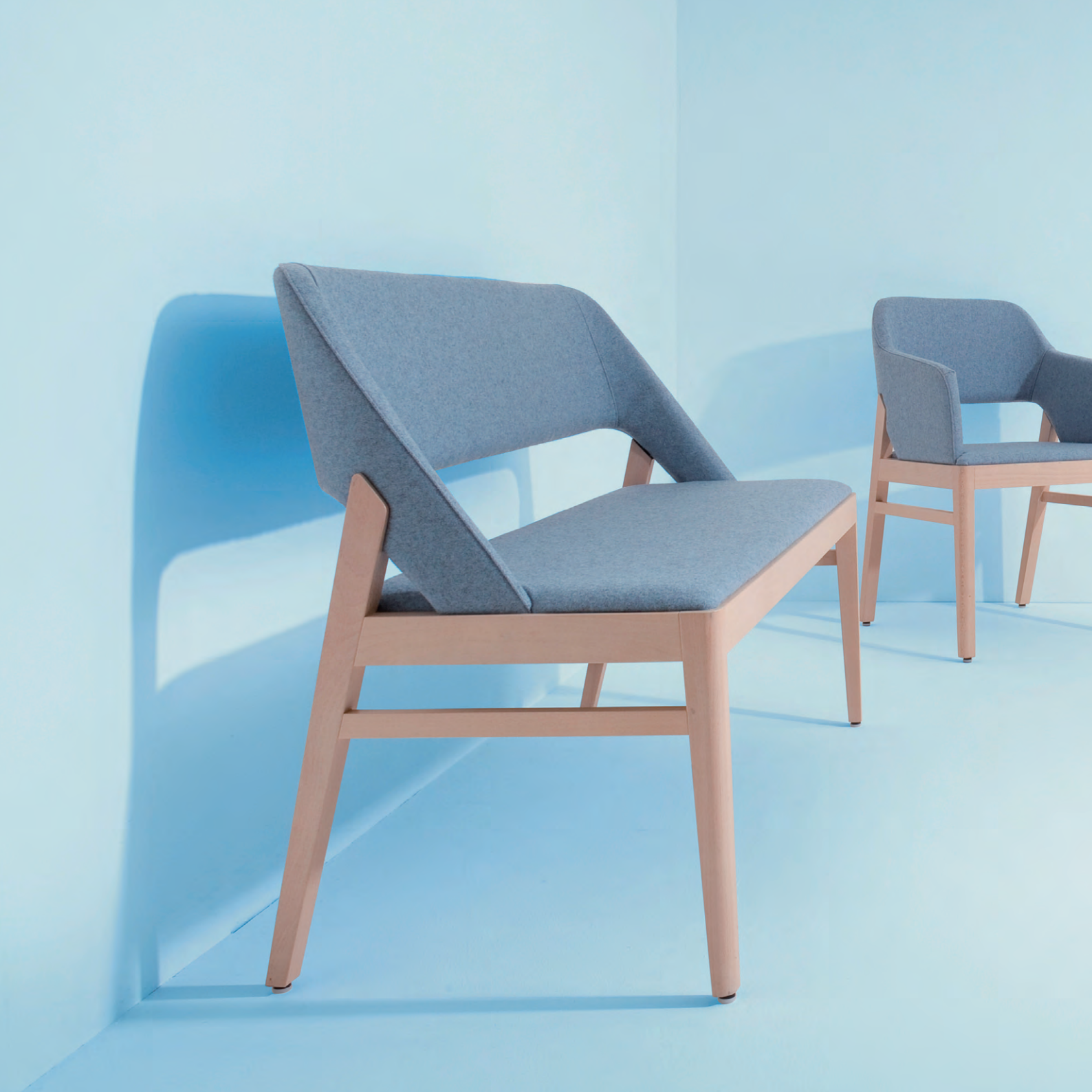

# ALBA

*Carlesi e Tonelli*



C-CW-BE-B325-AC



C-CW-BE-B325-AL



C-CW-BE-B325-ST

Price list \_ P.215



# AURA

*Carlesi e Tonelli*





BB

C-CW-BE-100-□-AC



005

C-CW-BE-100-□-AL



005

C-CW-BE-100-□-ST

Frame Color

BB

Bleached  
beech

005

Light  
walnut

Price list \_ P.215





C-CW-BE-011



021

C-CW-BE-□

Frame Color



Natural



Smoke brown



C-CW-BE-030



C-SB-BE-040

# MUSA

AREA 44



# MOON LIGHT

*Gabriel Teixidó*



C-CW-CL-020



C-CW-CL-030



C-CS-CL-050





C-CW-CL-150



C-CW-CL-170



Stool >> P.181

**ARO**  
*Carlos Tíscar*







C-CW-CE-030-AL/C-CW-CE-031-AL

Frame Color

- 030 Dark brown
- 031 Natural



C-CW-CE-020A-AC/C-CW-CE-021A-AC

Frame Color

- 020 Dark brown
- 021 Natural

# CF CHAIR

Creare



Price list \_ P.216



# RU CHAIR

*Creare*



C-CW-CE-010



C-TW-CE-020/021/022





# FRAME

*Paola Navone*



C-CW-VD-B353-□-01



C-CW-VD-B353-□-06



C-CW-VD-B353-□-11



C-CW-VD-B353-□-14

Frame Color

- NAT
- LWG
- Oak natural
- White

Price list \_ P.216,217



# LACLASICA

*Jesus Gasca*



C-CW-SA-010



C-CW-SA-011



C-CW-SA-012



C-CW-SA-013



# MIXIS

*Mario Ferrarini*





C-CW-CG-011



C-CW-CG-012-□



C-CW-CG-020-□

Color

M2	M6	M7	M9	M10
Light gray	White	Green	Yellow	Light blue





C-CS-CG-B331-□-SB



C-CS-CG-B331-□-PB

Color

- |   |   |   |
|---|---|---|
|  PWH |  PBK |  PGY |
| White   | Black   | Dark gray   |

# MIXIS AIR

*Mario Ferrarini*



Price list \_ P.217



# POLA LIGHT

*LC Studio*



Color

P1 White	P2 Gray	P3 Dark gray	P4 Black
P5 Light blue	P6 Green	P7 Red	





PBK

C-CS-CG-B328-□-4L



PWH

C-CS-CG-B328-□-SB

※座クッションは別売りです。

# NETT

*Ton Haas*



Color

PWH  
 White

PBK  
 Black

PGR  
 Green

Price list \_ P.218



C-CS-CG-B330-BK-WP ※座クッションは別売りです。



GR

C-CS-CG-B330-□-4L



BU

C-CS-CG-B330-□-SB



BK

C-CS-CG-B330-□-PB

※座クッションは別売りです。

# POLA ROUND

LC Studio

Color

WH	RE	YE
White	Red	Yellow
BU	GR	BK
Blue	Gray	Black

Price list \_ P.218



# KAY

*Leonardo Rossano*





C-CS-TE-B356-08 (回転タイプ)  
C-CS-TE-B356-07 (回転・昇降タイプ)





C-CW-AT-B318-□-AC



C-CW-AT-B318-□-ST

Frame Color

- T3 Natural
- T2 Stained oak



C-CS-AT-B318-M7-ST

# KABIRA

*Kensaku Oshiro*



# MÁNI

*Welling Ludvik*



C-CS-AT-B319-4L



C-CS-AT-B319-SP



C-CS-AT-B319-HO



# VERVE

*Geckeler Michels*



C-CS-FA-B336-3702



C-CS-FA-B336-3741



C-CS-FA-B336-3700



C-CS-FA-B336-3732



C-CS-FA-B336-3722







PN-21

座パット無: C-CS-FA-B335-□-20  
座パット付: C-CS-FA-B335-□-21



WH-30

座パット無: C-CS-FA-B335-□-30  
座パット付: C-CS-FA-B335-□-31



EB

座パット無: C-CS-FA-B335-□  
座パット付: C-CS-FA-B335-□-01



BK-11

座パット無: C-CS-FA-B335-□-10  
座パット付: C-CS-FA-B335-□-11

# ACME

Geckeler Michels

### Color





**CILA**

*Lievore Altherr*



C-CS-AR-B357-07



C-CS-AR-B357-09



C-CS-AR-B357-19

Price list \_ P.219



# CATIFA 46

*Lievore Altherr Molina*



※イメージは別色仕様です。



C-CS-AR-010-□



C-CS-AR-011-□

Chair

Color



Price list \_ P.219



# SLIM

*Paolo Vernier*



C-CS-MJ-B342-TS



C-CS-MJ-B342-CU-U64



C-CS-MJ-B342-CU-U66







C-CS-MJ-B343-S-□



C-CS-MJ-B343-TS



C-CS-MJ-B343-65-□  
C-CS-MJ-B343-75-□



C-CS-MJ-B343-65TS  
C-CS-MJ-B343-75TS

Wood Color

- AS Solid ash
- WN Solid walnut bark

# MASTER

Paolo Vernier



# A-COLLECTION

*Fran Silvestre*



C-CW-CL-B326-□-P/R  
(W400)



C-CW-CL-B326-□-1P/1R  
(W480)



C-CW-CL-B326-□-2P/2R  
(W480 肘付)



C-CW-CL-B326-□-3P/3R  
(W570)



C-CW-CL-B326-□-4P/4R  
(W570 肘付)



P(布張り)

R

Color

1 White 3 Black

Price list \_ P.220





C-CS-SA-080-AC (布張り)  
C-CS-SA-081-AC (背:メッシュ張り 座:エコレザー張り)



C-CS-SA-100-AL (ポリプロピレン)  
C-CS-SA-111-AC (エコレザー張り)



C-CN-SA-070-AC

**GAS**  
*Jesús Gasca*





C-CS-SA-050 □

Chair

# GLOBUS

*Jesús Gasca*

## Color



Price list \_ P.220







C-CG-PT-B357-C2



C-CG-PT-B357-G9

**SAT**  
*Marco zito*



# SIGN

*Piergiorgio Cazzaniga*



C-CG-MF-B354-FI-□

- Color
- 54  
 Black  
chrome
  - 55  
 Gold  
chrome
  - 56  
 Pink gold  
chrome



C-CG-MF-B354-MC-□

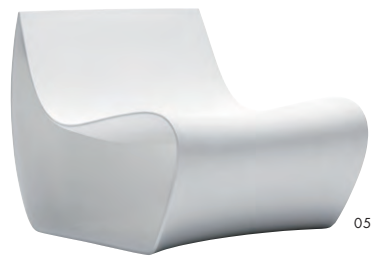

C-CG-MF-B354-MA-□

- Color
- 05  
 White
  - 36  
 Cement
  - 50  
 Mud
  - 52  
 Navy  
blue
  - 57  
 Corten



C-CG-MF-B354-BS-□  
for kids

- Color
- 07  
 White
  - 33  
 Green
  - 35  
 Yellow
  - 30  
 Orange
  - 29  
 Red
  - 58  
 Light  
blue
  - 59  
 Pink

Price list \_ P.220,221





C-CW-CE-070

Chair

# BT STOOL

*Creare*



# ARO

*Carlos Tíscar*



C-CW-CL-200



C-CW-CL-190



Chair >> P.133



# APELLE JUMP

*Beatriz Sempere*





※ツール以外は参考製品です。



C-CS-MJ-B344-45



C-CS-MJ-B344-65



C-CS-MJ-B344-75



# BARBRY

*Aurelien Barbry*



C-CS-FA-B337-B



C-CS-FA-B337-B1

Chair

Footrest

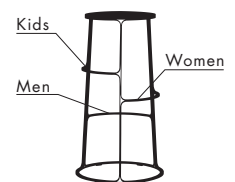

Price list \_ P.221





C-CS-BD-B323-ML



C-CS-BD-B323-MH



C-CS-BD-B323-WL



C-CS-BD-B323-WH

# JAMAICA STOOL

*Pepe Cortès*





C-CS-SA-040



C-CS-SA-030



C-CS-SA-020

**ONDA**  
*Jesús Gasca*





Outdoor



# OBI

Toan Nguyen



B1398

C-CS-VN-B351-DC-□



B133

C-SF-VN-B351-AC-□



B133

Color

B1398

Charcoal

B133

Brown

C-SF-VN-B351-SF-□



# BOLD

*Giulio Iacchetti*



N4

C-SG-PT-B347-□-AC



Outdoor

C2



N4

C-SG-PT-B347-□-SF



N4

C-TG-PT-B347-□-T

Color



Price list \_ P.222



# LAPALA

*Lievore Altherr Pillet*



C-CS-EM-B332-□-596



C-CS-EM-B332-□-590

Color

100 101  
White Black

Price list \_ P.222



# CLEVER

*R&S Varaschin*





C-CW-VN-B352-□

Frame Color  
 AC7 AC8  
 Light gray Dark gray



C-CW-VN-B352-AC4



C-CW-VN-B352-AC3



AC1

C-CW-VN-B352-□

Frame Color  
 AC1 AC2  
 Light gray Dark gray



AC6

C-CW-VN-B352-□

Frame Color  
 AC5 AC6  
 Light gray Dark gray

Outdoor



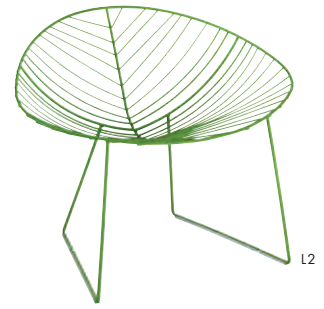

C-CG-AR-010-□  
座パット:C-CG-AR-020-KC-□



C-CG-AR-030-□  
座パット:C-CG-AR-040-KC-□

Outdoor

# LEAF

Lievore Altherr Molina



Price list \_ P.222



# LEAF

*Lievore Altherr Molina*



C-TG-AR-050T



C-TG-AR-060T



C-TG-AR-070T



# JUNO

James Irvine



C-CG-AR-110-AL-□



C-CG-AR-130-AC-□



C-CG-AR-120-AL-□



C-CG-AR-140-AC-□

Color

J1	J2	J3
White	Yellow	Orange
J4	J5	
Beige	Black	





## Price List

## DIDOT

	★C-SF-A082-SF1 仕様/主材:アッシュ材・ウレタン塗装 背座:布張 サイズ/W3,340×D1,670×H800×SH400	¥990,000 (本体価格)	» [Page/P.18]
	★C-SF-A082-SF5 仕様/主材:アッシュ材・ウレタン塗装 背座:布張 サイズ/W3,340×D1,670×H800×SH400	¥1,100,000 (本体価格)	» [Page/P.18]
	★C-SF-A082-SF3 仕様/主材:アッシュ材・ウレタン塗装 背座:布張 サイズ/W2,580×D800×H800×SH400	¥470,000 (本体価格)	» [Page/P.18]
	★C-SF-A082-SF2 (背合わせ両面タイプ) 仕様/主材:アッシュ材・ウレタン塗装 背座:布張 サイズ/W3,260×D1,520×H800×SH400	¥880,000 (本体価格)	» [Page/P.18]
	★C-SF-A082-SF4 仕様/主材:アッシュ材・ウレタン塗装 背座:布張 サイズ/W3,260×D800×H800×SH400	¥590,000 (本体価格)	» [Page/P.18]
	★C-SF-A081-AC 仕様/主材:アッシュ材・ウレタン塗装 背座:布張 サイズ/W760×D760×H830×SH400	¥120,000 (本体価格)	» [Page/P.19]
	★C-CW-A080-AC1 仕様/主材:アッシュ材・ウレタン塗装 背座:布張 サイズ/W750×D710×H730×SH400	¥89,800 (本体価格)	» [Page/P.19]
	★C-CW-A080-AC2 仕様/主材:アッシュ材・ウレタン塗装 背座:布張 サイズ/W600×D600×H815×SH450	¥77,000 (本体価格)	» [Page/P.19]
	★C-CW-A080-ST 仕様/主材:アッシュ材・ウレタン塗装 背座:布張 サイズ/W613×D500×H1,080×SH750	¥82,000 (本体価格)	» [Page/P.19]

## YVES

	★C-SF-A083-AC1 仕様/背座:布張 脚部:アッシュ突板・ウレタン塗装 サイズ/W827×D630×H750×SH420	¥159,000 (本体価格)	» [Page/P.21]
	★C-SF-A083-ROA 仕様/背座:布張 脚部:アッシュ突板・ウレタン塗装 サイズ/W812×D630×H750×SH420	¥138,000 (本体価格)	» [Page/P.21]
	★C-SF-A083-SCK 仕様/背座:布張 脚部:アッシュ突板・ウレタン塗装 サイズ/W867×D550×H420	¥80,000 (本体価格)	» [Page/P.21]
	★C-SF-A083-SF 仕様/背座:布張 脚部:アッシュ突板・ウレタン塗装 サイズ/W1,627×D630×H650×SH420	¥268,000 (本体価格)	» [Page/P.21]
	★C-SF-A083-RAK 仕様/背座:布張 脚部:アッシュ突板・ウレタン塗装 サイズ/W1,615×D630×H750×SH420	¥228,000 (本体価格)	» [Page/P.21]
	★C-SF-A083-B2-A 仕様/座:布張 脚部:アッシュ突板・ウレタン塗装 サイズ/W1,627×D550×H420	¥149,000 (本体価格)	» [Page/P.21]
	★C-SF-A083-B2-B 仕様/座:布張 脚部:アッシュ突板・ウレタン塗装 サイズ/W1,470×D550×H420	¥149,000 (本体価格)	» [Page/P.21]
	★C-TL-A083 仕様/天板:大理石 脚部:ステンレス サイズ/W660×D510×H400	¥282,000 (本体価格)	» [Page/P.23]

## EMILY

	★C-SF-A086-AC 仕様/背座:布張 脚部:アッシュ材・ウレタン塗装 サイズ/W700×D750×H750×SH400	¥128,000 (本体価格)	» [Page/P.24]
	★C-SF-A086-LC 仕様/背座:布張 脚部:アッシュ材・ウレタン塗装 サイズ/W1,600×D750×H750×SH400	¥298,000 (本体価格)	» [Page/P.25]
	★C-SF-A086-SF 仕様/背座:布張 脚部:アッシュ材・ウレタン塗装 サイズ/W2,000×D750×H750×SH400	¥380,000 (本体価格)	» [Page/P.25]

**◆C-CW-CY-030**

¥77,000 (本体価格)

» [Page/P.27]

仕様/背座:布張 脚部:ビーチ  
サイズ/W490×D540×H800×SH450**◆C-CW-CY-040**

¥84,000 (本体価格)

» [Page/P.27]

仕様/背座:布張 脚部:ビーチ  
サイズ/W580×D620×H800×SH410**◆C-CW-CY-050**

¥95,300 (本体価格)

» [Page/P.27]

仕様/背座:布張 脚部:ビーチ フットレスト:ステンレスHL  
サイズ/W450×D500×H1,095×SH810**C-1****◆C-SF-CY-060**

¥174,000 (本体価格)

» [Page/P.31]

仕様/背座:布張  
サイズ/W1,600×D800×H620×SH320**◆C-SF-CY-061**

¥164,000 (本体価格)

» [Page/P.31]

仕様/背座:布張  
サイズ/W1,600×D800×H620×SH320**◆C-SF-CY-062**

¥177,000 (本体価格)

» [Page/P.31]

仕様/背座:布張  
サイズ/W1,600×D800×H620×SH320**◆C-SF-CY-063**

¥184,000 (本体価格)

» [Page/P.31]

仕様/背座:布張  
サイズ/W1,600×D800×H620×SH320**◆C-SF-CY-064**

¥80,000 (本体価格)

» [Page/P.31]

仕様/座:布張  
サイズ/W800×D800×H320**◆C-TT-CY-065**

¥105,800 (本体価格)

» [Page/P.31]

仕様/本体:オーク材  
サイズ/W800×D800×H40**R-2****◆C-CW-CY-010**

¥83,500 (本体価格)

» [Page/P.32]

仕様/背座:布張 脚部:ビーチ材  
サイズ/W490×D565×H765×SH430**◆C-CW-CY-020**

¥72,000 (本体価格)

» [Page/P.33]

仕様/背座:布張 脚部:ビーチ材 フットレスト:ステンレスHL  
サイズ/W350×D350×H800**The Frame****★C-SF-A089-OT**

¥142,000 (本体価格)

» [Page/P.34]

仕様/背座:布張 スチールパイプ・焼付塗装  
サイズ/W800×D660×H400**★C-SF-A089-S1**

¥220,000 (本体価格)

» [Page/P.35]

仕様/背座:布張 スチールパイプ・焼付塗装  
サイズ/W800×D1,000×H720×SH400**★C-SF-A089-S2**

¥368,000 (本体価格)

» [Page/P.35]

仕様/背座:布張 スチールパイプ・焼付塗装  
サイズ/W1,600×D1,000×H720×SH400**★C-SF-A089-S3**

¥535,000 (本体価格)

» [Page/P.35]

仕様/背座:布張 スチールパイプ・焼付塗装  
サイズ/W2,400×D1,000×H720×SH400**★C-SF-A089-KC**

¥15,000 (本体価格)

» [Page/P.35]

仕様/綿:布張  
サイズ/W750×D250×H400**★C-CS-A079**

¥63,000 (本体価格)

» [Page/P.37]

仕様/背座:布張 フレーム:スチール・焼付塗装(ブラック)  
サイズ/W420×D565×H845×SH450**ENKO****★C-SF-A061-AC**

¥120,000 (本体価格)

» [Page/P.38]

仕様/背座:布張 脚部:ビーチ材・ウレタン塗装  
サイズ/W880×D830×H840×SH400**★C-SF-A061-SF**

¥198,000 (本体価格)

» [Page/P.39]

仕様/背座:布張 脚部:ビーチ材・ウレタン塗装  
サイズ/W1,930×D830×H840×SH400**★C-SF-A062-AC**

¥98,000 (本体価格)

» [Page/P.39]

仕様/背座:布張 脚部:ビーチ材・ウレタン塗装  
サイズ/W720×D700×H755×SH420**★C-SF-A063-ST**

¥55,000 (本体価格)

» [Page/P.39]

仕様/座:布張 脚部:ビーチ材・ウレタン塗装  
サイズ/W460×D460×H720

## oalt



★C-SF-A069・□

仕様/座:布張 フレーム:アッシュ材・ウレタン塗装  
サイズ/W604×D600×H700×SH390

¥120,000 (本体価格)

»[Page/P.41]

[Wood Color variation]  
Natural (NA)、Black (BK)

## oalt hold



★C-SF-A070・□

仕様/背座:布張 フレーム:アッシュ材  
サイズ/W605×D600×H700×SH390

¥140,000 (本体価格)

»[Page/P.43]

[Wood Color variation]  
Natural (NA)、Black (BK)

## uask



★C-SF-A073

仕様/脚部:ステンレスブロンズ色塗装  
サイズ/W800×D780×H700×SH410

¥145,000 (本体価格)

»[Page/P.45]

## SCOOP



★C-SF-A077-AC-M

仕様/本体:ステンレス鏡面  
サイズ/W700×D715×H685×SH405

¥980,000 (本体価格)

»[Page/P.47]



★C-SF-A077-S3-M

仕様/本体:ステンレス鏡面  
サイズ/W1,800×D715×H685×SH405

¥1,500,000 (本体価格)

»[Page/P.47]



★C-SF-A077-S4-M

仕様/本体:ステンレス鏡面  
サイズ/W2,200×D715×H685×SH405

¥1,800,000 (本体価格)

»[Page/P.47]



★C-SF-A077-AC

仕様/本体:ウォルナット突板  
サイズ/W700×D715×H685×SH405

¥211,000 (本体価格)

»[Page/P.49]



★C-SF-A077-ST

仕様/本体:ウォルナット突板  
サイズ/W550×D565×H1,060×SH760

¥226,500 (本体価格)

»[Page/P.49]



★C-SF-A077-AC-KIZ

仕様/本体:ウォルナット突板 for kids  
サイズ/W470×D485×H470×SH250

¥184,000 (本体価格)

»[Page/P.49]



★C-SF-A077-S3

仕様/本体:ウォルナット突板  
サイズ/W1,800×D715×H685×SH405

¥565,000 (本体価格)

»[Page/P.49]



★C-SF-A077-S4

仕様/本体:ウォルナット突板  
サイズ/W2,200×D715×H685×SH405

¥705,000 (本体価格)

»[Page/P.49]

## RINg



■S-SM-A109

仕様/ハンドル:Φ15.9スチールパイプゴールドメッキ(真鍮風) 脚部:Φ10スチールロッドゴールドメッキ(真鍮風)  
サイズ/W700×D660×H700×SH420

¥353,000 (本体価格)

»[Page/P.51]

## nuts



★C-SF-A084

仕様/FRP 塗装仕上げ  
サイズ/W795×D1,240×H825×SH310

¥698,000 (本体価格)

»[Page/P.53]

## SVEVO



★C-SF-NI-B358-SF

仕様/背座:本革張  
サイズ/W2,290×D990×H930×SH470

¥642,000 (本体価格)

»[Page/P.55]

## AURA



★C-SF-NI-050・□

仕様/主材:オーク材 背座:本革張  
サイズ/W860×D800×H860

¥230,000 (本体価格)

»[Page/P.57]

[Color variation]  
White (A1)、Brown (A2)



★C-SF-NI-060・□

仕様/主材:オーク材 背座:本革張  
サイズ/W860×D820×H1,180

¥269,000 (本体価格)

»[Page/P.57]

[Color variation]  
White (A1)、Brown (A2)

## ANTEPRIMA



★C-SF-NI-110・□

仕様/背座:本革張 脚部:スチール  
サイズ/W770×D770×H700×SH450

¥274,000 (本体価格)

»[Page/P.58]

[Color variation]  
Brown (A4)、White (A5)、Black (A6)

## VIAGGIO



★C-SF-NI-010-V1

¥280,000 (本体価格)

»[Page/P.59]

仕様/主材:オーク材 背座:布張 肘部:スチール  
サイズ/W740xD890xH780xSH430

[Color variation]  
Gray(V1)

## DON GIOVANNI



★C-SF-NI-020-S2-D1 (2人掛)

¥503,000 (本体価格)

»[Page/P.60]

仕様/背座:本革張 脚部:スチール塗装(ブラック)  
サイズ/W1,930xD1,020xH800



★C-SF-NI-030-S3-D1 (3人掛)

¥575,000 (本体価格)

»[Page/P.60]

仕様/背座:本革張 脚部:スチール塗装(ブラック)  
サイズ/W2,340xD1,020xH800

## DOLLY



★C-SF-NI-040-□

¥241,000 (本体価格)

»[Page/P.61]

仕様/背座:本革張 脚部:スチール塗装  
サイズ/W950xD910xH840xSH450

[Color variation]  
Black (D3)、White (D4)、Dark brown (D5)

## CAMMEO



★C-SF-NI-120-□

¥333,000 (本体価格)

»[Page/P.63]

仕様/背座:本革張 フレーム:スチールクロムメッキ  
サイズ/W770xD850xH760xSH440

[Color variation]  
Black (C1)、White (C2)

## LOUNGER



★C-SF-BD-B321-HL-□

¥828,000 (本体価格)

»[Page/P.64]

仕様/背座:革張 シート:成型合板(アッシュ突板(FR13)・ウォールナット突板(NG)) 脚部:スチール・塗装  
サイズ/W760xD910xH990xSH420xAH620

[Wood Color variation]  
Ash natural (FR13)、Walnut (NG)



★C-SF-BD-B321-H-□

¥639,000 (本体価格)

»[Page/P.65]

仕様/背座:布張 シート:成型合板(アッシュ突板(FR13)・ウォールナット突板(NG)) 脚部:スチール・塗装  
サイズ/W760xD910xH990xSH420xAH620

[Wood Color variation]  
Ash natural (FR13)、Walnut (NG)



★C-SF-BD-B321-L-□

¥458,000 (本体価格)

»[Page/P.65]

仕様/背座:布張 シート:成型合板(アッシュ突板(FR13)・ウォールナット突板(NG)) 脚部:スチール・塗装  
サイズ/W750xD790xH790xSH410xAH620

[Wood Color variation]  
Ash natural (FR13)、Walnut (NG)

## HAMPER



★C-SF-PE-B345-ACA-□

¥580,000 (本体価格)

»[Page/P.67]

仕様/主材:アッシュ材・アクリル塗装 背座:布張  
サイズ/W1,000xD1,020xH780xSH400

[Frame Color variation]  
White ash (WA)、Natural ash (NA)



★C-SF-PE-B345-ACO-□

¥605,000 (本体価格)

»[Page/P.67]

仕様/主材:オーク材・アクリル塗装 背座:布張  
サイズ/W1,000xD1,020xH780xSH400

[Frame Color variation]  
White oak (WO)、Natural oak (NO)



★C-SF-PE-B345-SFA-□

¥698,000 (本体価格)

»[Page/P.67]

仕様/主材:アッシュ材・アクリル塗装 背座:布張  
サイズ/W2,100xD1,020xH780xSH400

[Frame Color variation]  
White ash (WA)、Natural ash (NA)



★C-SF-PE-B345-SFO-□

¥730,000 (本体価格)

»[Page/P.67]

仕様/主材:オーク材・アクリル塗装 背座:布張  
サイズ/W2,100xD1,020xH780xSH400

[Frame Color variation]  
White oak (WO)、Natural oak (NO)

## MAGNUM



★C-SF-SL-B348-55Z

¥279,000 (本体価格)

»[Page/P.69]

仕様/背座:布張 脚部:スチール・金メッキ  
サイズ/W780xD780xH690xSH430



★C-SF-SL-B348-41

¥86,000 (本体価格)

»[Page/P.71]

仕様/背座:布張  
サイズ/W530xD520xH760xSH470



★C-SF-SL-B348-47

¥122,600 (本体価格)

»[Page/P.71]

仕様/背座:布張 脚部:スチール・ラッカー塗装  
サイズ/W530xD520xH760xSH470

## TORTUGA



★C-SF-SL-B349

¥180,000 (本体価格)

»[Page/P.73]

仕様/背座:布張 脚部:スチール  
サイズ/W810xD600xH770xSH420

## TALO

	★C-SF-SL-020-S1	¥132,000 (本体価格)	»[Page/P.75]
	仕様/主材:オーク材・ウレタン塗装(ブラウン) 背座:布張 置きクッション別途 サイズ/W660xD730xH730xSH400		
	★C-SF-SL-021-S1	¥132,000 (本体価格)	»[Page/P.75]
	仕様/主材:オーク材・ウレタン塗装(ナチュラル) 背座:布張 置きクッション別途 サイズ/W660xD730xH730xSH400		
	★C-SF-SL-022-S2	¥178,000 (本体価格)	»[Page/P.75]
	仕様/主材:オーク材(ナチュラル) 背座:布張 置きクッション別途 サイズ/W1,210xD730xH730xSH400		
	★C-SF-SL-030-KC	¥15,000 (本体価格)	»[Page/P.75]
	仕様/布張 サイズ/W420xD250xt70		

## NIDO

	★C-SF-SL-030	¥138,000 (本体価格)	»[Page/P.77]
	仕様/主材:アッシュ材 背座:布張 サイズ/W690xD730xH730xSH410		





## ELEPHANT

	★C-SB-SL-060-S1	¥65,000 (本体価格)	»[Page/P.79]
	仕様/脚部:スチール 座:布張 サイズ/W450xD450xH420		
	★C-SB-SL-070-S2	¥95,000 (本体価格)	»[Page/P.79]
	仕様/脚部:スチール 座:布張 サイズ/W900xD450xH420		
	★C-SB-SL-080-S2T	¥117,000 (本体価格)	»[Page/P.79]
	仕様/脚部:スチール 座:布張 その他:天板:オーク サイズ/W900xD450xH510xSH420		

## KONOHA

	★C-SB-SL-010	¥457,000 (本体価格)	»[Page/P.81]
	仕様/フレーム:ビーチ材・ウレタン塗装 座:布張(OUTBACK指定) 脚部:ステンレス サイズ/W1,420xD680xH400		
	★C-SB-SL-020	¥492,000 (本体価格)	»[Page/P.81]
	仕様/フレーム:ビーチ材・ウレタン塗装 座:布張(OUTBACK指定) 脚部:ステンレス サイズ/W1,600xD770xH400		
	★C-SB-SL-030	¥558,000 (本体価格)	»[Page/P.81]
	仕様/フレーム:ビーチ材・ウレタン塗装 座:布張(OUTBACK指定) 脚部:ステンレス サイズ/W1,740xD840xH400		
	★C-SB-SL-040	¥635,000 (本体価格)	»[Page/P.81]
	仕様/フレーム:ビーチ材・ウレタン塗装 座:布張(OUTBACK指定) 脚部:ステンレス サイズ/W2,090xD1,010xH400		
	★C-SB-SL-050	¥723,000 (本体価格)	»[Page/P.81]
	仕様/フレーム:ビーチ材・ウレタン塗装 座:布張(OUTBACK指定) 脚部:ステンレス サイズ/W2,350xD1,130xH400		





## COSTURA

	★C-SF-SA-B361-AC	¥248,000 (本体価格)	»[Page/P.83]
	仕様/本体:布張 FTL004 脚部:アルミ(エポキシ塗装) サイズ/W760xD900xH850xSH420xAH700		
	★C-SF-SA-B361-SF	¥478,000 (本体価格)	»[Page/P.83]
	仕様/本体:布張 FMD832 脚部:アルミ(エポキシ塗装) サイズ/W2,160xD900xH850xSH420xAH700		
	★C-SF-SA-B361-OT	¥105,000 (本体価格)	»[Page/P.83]
	仕様/本体:布張 FMD832 脚部:アルミ(エポキシ塗装) サイズ/W700xD900xH420		
	★C-SF-SA-B361-CL	¥275,000 (本体価格)	»[Page/P.83]
	仕様/本体:布張 FMA054 脚部:アルミ(エポキシ塗装) サイズ/W980xD1,600xH850xSH420xAH700		

## NUBE

	★C-SF-SA-010	¥196,000 (本体価格)	»[Page/P.85]
	仕様/背座:布張 フレーム:スチールクロムメッキ サイズ/W690xD690xH650xSH440		
	★C-SF-SA-011	¥196,000 (本体価格)	»[Page/P.85]
	仕様/背座:布張 フレーム:スチールクロムメッキ サイズ/W690xD690xH650xSH440		
	★C-SF-SA-012	¥196,000 (本体価格)	»[Page/P.85]
	仕様/背座:布張 フレーム:スチールクロムメッキ サイズ/W690xD690xH650xSH440		

## TK-1

	◆C-SB-CE-020 仕様/背座:布張 脚部:ステンレスヘアライン サイズ/W900xD900xH800xSH450	¥129,000 (本体価格)	》【Page/P.87】
	◆C-SB-CE-021 仕様/背座:布張 脚部:ステンレスヘアライン サイズ/W900xD900xH700xSH450	¥131,000 (本体価格)	》【Page/P.87】
	★C-TL-CE-022T 仕様/MDF材(ホワイト全艶) 脚部:ステンレスヘアライン サイズ/W890xD890xH430	¥278,000 (本体価格)	》【Page/P.87】
	◆C-TL-CE-030 仕様/MDF材(ブラック半艶) サイズ/W300xD300xH550	¥93,000 (本体価格)	》【Page/P.87】

## COLINA

	♣C-SF-AR-060 仕様/背座:布張 脚部:スチール・粉体塗装 サイズ/W960xD735xH710xSH400	¥309,000 (本体価格)	》【Page/P.89】
	♣C-SF-AR-030 仕様/背座:布張 サイズ/W1,025xD840xH730xSH400	¥313,000 (本体価格)	》【Page/P.89】
	♣C-SF-AR-050 仕様/背座:布張 脚部:ウエンジ材 サイズ/W960xD745xH690xSH400	¥262,000 (本体価格)	》【Page/P.89】
	♣C-SF-AR-020 仕様/背座:布張 サイズ/W960xD745xH690xSH400	¥277,000 (本体価格)	》【Page/P.89】
	♣C-SF-AR-040 仕様/背座:布張 脚部:スチール粉体塗装 サイズ/W960xD745xH690xSH400	¥245,000 (本体価格)	》【Page/P.89】

## CATIFA80

	♣C-CS-AR-090 仕様/背座:布張 脚部:アルミ・ポリッシュ オートリターン付 サイズ/W870xD870xH690xSH375	¥260,000 (本体価格)	》【Page/P.91】
	♣C-CS-AR-100 仕様/背座:布張 脚部:スチール・クロムメッキ サイズ/W850xD690xH715xSH395	¥225,000 (本体価格)	》【Page/P.91】





## ZINTA

	♣C-SB-AR-020-S3 仕様/背座:布張 脚部:アルミ塗装(ブラック) 置きクッション別途 サイズ/W3,270xD995xH770xSH420	¥1,130,000 (本体価格)	》【Page/P.93】
---	--	-------------------	--------------

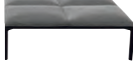

## PLUS

	★C-SF-LA-B338 仕様/背座:布張 パネル:スチール・粉体塗装 木部:オーク材・染色塗装仕上げ セットサイズ/W3,810xD930xH1,630xSH400/500	¥1,790,000 (本体価格)	》【Page/P.95】
---	--	-------------------	--------------

## ADD

	★C-SF-LA-040-S2 仕様/背座:布張 脚部:アルミ(ホワイト) サイズ/W1,400xD700xH730xSH400	¥425,000 (本体価格)	》【Page/P.97】
	★C-SF-LA-010-S3 仕様/背座:布張 脚部:アルミ(ブラック) φ400テーブル付 サイズ/W1,950xD700xH730xSH400	¥504,000 (本体価格)	》【Page/P.97】
	★C-TL-LA-020T 仕様/天板:メラミン化粧板(ホワイト) 脚部:アルミ(ホワイト) サイズ/W1,170xD1,170xH330	¥410,000 (本体価格)	》【Page/P.97】
	★C-SB-LA-030 仕様/座:布張 脚部:アルミ(ブラック) サイズ/W1,170xD1,170xH390	¥367,000 (本体価格)	》【Page/P.97】
	★C-SB-LA-070-S5 仕様/座:布張 脚部:アルミ(ホワイト) サイズ/W3,520xD590xH400xSH390	¥581,000 (本体価格)	》【Page/P.97】

## BILDU

	★C-SB-SX-B359-S4-NA 仕様/シート:成型合板(オーク突板) フレーム:アルミ(エポキシ塗装) サイズ/W2,500xD660xH770	¥248,000 (本体価格)	》[Page/P.98]
	★C-SB-SX-B359-S4-PVC 仕様/フレーム:アルミ(エポキシ塗装) サイズ/W2,500xD660xH770	¥372,000 (本体価格)	》[Page/P.98]





## SLAM

	★C-SB-SX-B360-S3A-□ 仕様/シート:ポリプロピレン フレーム:アルミ サイズ/W1,680xD530xH790	¥133,000 (本体価格)	》[Page/P.99]
	★C-SB-SX-B360-S4-□ 仕様/シート:ポリプロピレン フレーム:アルミ サイズ/W2,250xD530xH790	¥137,000 (本体価格)	》[Page/P.99]

## DNA

	★C-SB-TE-B355-2T 仕様/主材:ビーチ成型合板 サイズ/W1,200xD480xH460	¥171,000 (本体価格)	》[Page/P.101]
	★C-SB-TE-B355-3T 仕様/主材:ビーチ成型合板 サイズ/W1,950xD480xH460	¥239,800 (本体価格)	》[Page/P.101]
	★C-SB-TE-B355-3R 仕様/主材:ビーチ成型合板 サイズ/W1,650xD480xH460	¥291,000 (本体価格)	》[Page/P.101]
	★C-SB-TE-B355-4R 仕様/主材:ビーチ成型合板 サイズ/W2,400xD480xH460	¥388,000 (本体価格)	》[Page/P.101]
	★C-SB-TE-B355-10R 仕様/主材:ビーチ成型合板 サイズ/W4,050xD2,130xH460	¥970,000 (本体価格)	》[Page/P.101]

## SHOWTIME

	★C-CW-BD-B320-N 仕様/シート:ビーチ成型合板(アッシュ突板)・クリアラッカー塗装 脚部:ビーチ成型合板・ラッカー塗装 サイズ/W550xD540xH890xSH440xAH650	¥116,000 (本体価格)	》[Page/P.112]
	★C-CW-BD-B320-□ 仕様/シート:ビーチ成型合板(アッシュ突板)・ラッカー塗装 脚部:ビーチ成型合板・ラッカー塗装 サイズ/W550xD540xH890xSH440xAH650	¥126,000 (本体価格)	》[Page/P.113]
	★C-CW-BD-B320-Y02 (座クッション) 仕様/ファブリック サイズ/W400xD440xT40	¥24,800 (本体価格)	》[Page/P.113]
	★C-CW-BD-B320-F18 (座クッション) 仕様/レザー サイズ/W400xD440xT40	¥36,800 (本体価格)	》[Page/P.113]

## SUITE

	★C-CW-MJ-B341-UTN 仕様/主材:オーク材・ラッカー塗装 背座:本革張 サイズ/W610xD540xH770xSH460xAH660	¥125,000 (本体価格)	》[Page/P.115]
	★C-CW-MJ-B341-K67 仕様/主材:アッシュ材・ラッカー塗装 背座:本革張 サイズ/W610xD540xH770xSH460xAH660	¥98,500 (本体価格)	》[Page/P.115]

## STRIKE

	★C-CW-MJ-B340-□・S 仕様/主材:アッシュ材・ラッカー塗装 背:スチール・塗装仕上げ サイズ/W480xD520xH790xSH460	¥58,800 (本体価格)	》[Page/P.117]
	★C-CW-MJ-B340-□・P 仕様/主材:アッシュ材・ラッカー塗装 背:スチール・塗装仕上げ サイズ/W540xD520xH790xSH460xAH640	¥61,800 (本体価格)	》[Page/P.117]
	★C-CW-MJ-B340-□・65 仕様/主材:アッシュ材・ラッカー塗装 背:スチール・塗装仕上げ サイズ/W480xD520xH980xSH660	¥74,500 (本体価格)	》[Page/P.117]
	★C-CW-MJ-B340-□・75 仕様/主材:アッシュ材・ラッカー塗装 背:スチール・塗装仕上げ サイズ/W480xD520xH1,080xSH760	¥79,500 (本体価格)	》[Page/P.117]



**★C·CW·MJ·B340·□·65P**

¥80,000 (本体価格)

»[Page/P.117]

仕様/主材:アッシュ材・ラッカー塗装 背:スチール・塗装仕上げ  
サイズ/W540xD520xH980xSH660[Steel Color variation]  
Sage green (SG)、Black (BK)**★C·CW·MJ·B340·□·75P**

¥85,400 (本体価格)

»[Page/P.117]

仕様/主材:アッシュ材・ラッカー塗装 背:スチール・塗装仕上げ  
サイズ/W540xD520xH1,080xSH760[Steel Color variation]  
Sage green (SG)、Black (BK)**BACI****★C·CW·PE·B346·WO**

¥107,000 (本体価格)

»[Page/P.119]

仕様/主材:オーク材・アクリル塗装 座:布張  
サイズ/W600xD550xH850xSH450**★C·CW·PE·B346·NA**

¥92,000 (本体価格)

»[Page/P.119]

仕様/主材:アッシュ材・アクリル塗装 座:布張  
サイズ/W600xD550xH850xSH450**BASICWOOD****★C·CW·FG·B333·□·AC**

¥87,500 (本体価格)

»[Page/P.121]

仕様/主材:ビーチ材・ウレタン塗装 背座:布張  
サイズ/W610xD570xH830xSH470xAH560[Frame Color variation]  
Walnut (M)、Wenge (W)**★C·CW·FG·B333·□·ST**

¥95,500 (本体価格)

»[Page/P.121]

仕様/主材:ビーチ材・ウレタン塗装 背座:布張  
サイズ/W550xD550xH1,120xSH600xAH950[Frame Color variation]  
Walnut (M)、Wenge (W)**KITE****★C·CW·FG·B334·□·S**

¥88,500 (本体価格)

»[Page/P.123]

仕様/主材:ビーチ材・ウレタン塗装 背座:布張  
サイズ/W550xD620xH800xSH470[Frame Color variation]  
White oak (OAK)、Walnut (M)**★C·CW·FG·B334·□·L**

¥120,000 (本体価格)

»[Page/P.123]

仕様/主材:ビーチ材・ウレタン塗装 背座:布張  
サイズ/W660xD670xH700xSH410[Frame Color variation]  
White oak (OAK)、Walnut (M)**ALBA****★C·CW·BE·B325·AC**

¥71,800 (本体価格)

»[Page/P.125]

仕様/主材:ビーチ材・ウレタン塗装 背座:布張  
サイズ/W560xD570xH830xSH470xAH700**★C·CW·BE·B325·AL**

¥64,800 (本体価格)

»[Page/P.125]

仕様/主材:ビーチ材・ウレタン塗装 背座:布張  
サイズ/W560xD570xH830xSH470**★C·CW·BE·B325·ST**

¥82,800 (本体価格)

»[Page/P.125]

仕様/主材:ビーチ材・ウレタン塗装 背座:布張  
サイズ/W520xD580xH1,080xSH770**AURA****★C·CW·BE·100·□·AC**

¥89,800 (本体価格)

»[Page/P.127]

仕様/主材:ビーチ材・ウレタン塗装 背座:布張  
サイズ/W550xD580xH870xSH470xAH670[Frame Color variation]  
Bleached beech (BB)、Light walnut (005)**★C·CW·BE·100·□·AL**

¥83,000 (本体価格)

»[Page/P.127]

仕様/主材:ビーチ材・ウレタン塗装 背座:布張  
サイズ/W550xD580xH870xSH470[Frame Color variation]  
Bleached beech (BB)、Light walnut (005)**★C·CW·BE·100·□·ST**

¥102,000 (本体価格)

»[Page/P.127]

仕様/主材:ビーチ材・ウレタン塗装 背座:布張  
サイズ/W520xD580xH1,080xSH770[Frame Color variation]  
Bleached beech (BB)、Light walnut (005)**MUSA****★C·CW·BE·011**

¥76,000 (本体価格)

»[Page/P.129]

仕様/背座:布張 脚部:アッシュ材(ブルー)  
サイズ/W470xD520xH880xSH480**★C·CW·BE·020**

¥102,000 (本体価格)

»[Page/P.129]

仕様/背座:布張 脚部:アッシュ材(ナチュラル)  
サイズ/W570xD580xH810xSH470**★C·CW·BE·021**

¥102,000 (本体価格)

»[Page/P.129]

仕様/背座:布張 脚部:アッシュ材(スモークブラウン)  
サイズ/W570xD580xH810xSH480**★C·CW·BE·030**

¥94,000 (本体価格)

»[Page/P.129]

仕様/背座:ビニールレザー張 脚部:アッシュ材(ブラウン)  
サイズ/W470xD520xH1,060xSH780**★C·SB·BE·040**

¥82,000 (本体価格)

»[Page/P.129]

仕様/座:布張 脚部:アッシュ材(スモークブラウン)  
サイズ/W1,240xD430xH460

## MOON LIGHT



★C-CW-CL-020

¥104,000 (本体価格) [】\[Page/P.131\]](#)

仕様/フレーム:ビーチ材・ウレタン塗装 背座:布張 脚部:ビーチ材  
サイズ/W590xD550xH740xSH460xAH650



★C-CW-CL-030

¥105,000 (本体価格) [】\[Page/P.131\]](#)

仕様/フレーム:ビーチ材・ウレタン塗装 背座:布張 脚部:ビーチ材  
サイズ/W590xD550xH740xSH460xAH650



★C-CS-CL-050

¥97,000 (本体価格) [】\[Page/P.131\]](#)

仕様/背座:布張 脚部:スチールクロムメッキ  
サイズ/W610xD550xH740xSH460xAH650

## ARO



★C-CW-CL-160

¥94,000 (本体価格) [】\[Page/P.132\]](#)

仕様/主材:ビーチ材(ダークブラウン) 背座:布張  
サイズ/W570xD580xH760xSH470



★C-CW-CL-150

¥93,000 (本体価格) [】\[Page/P.133\]](#)

仕様/主材:ビーチ材(ナチュラル) 背座:布張  
サイズ/W570xD580xH760xSH470



★C-CW-CL-170

¥94,000 (本体価格) [】\[Page/P.133\]](#)

仕様/主材:ビーチ材(ブラウン) 背座:布張  
サイズ/W710xD700xH740xSH430



★C-CW-CL-190

¥76,000 (本体価格) [】\[Page/P.181\]](#)

仕様/主材:ビーチ材(ブラウン) 座:布張  
サイズ/φ420xH800



★C-CW-CL-200

¥66,000 (本体価格) [】\[Page/P.181\]](#)

仕様/主材:ビーチ材(ナチュラル) 座:布張  
サイズ/φ410xH650

## CF CHAIR



◆C-CW-CE-030-AL

¥78,500 (本体価格) [】\[Page/P.135\]](#)

仕様/主材:ホワイトオーク材(ダークブラウン) 座:ビニールレザー張  
サイズ/W490xD510xH765xSH430

※ロット20脚の場合の価格です。



◆C-CW-CE-031-AL

¥78,500 (本体価格) [】\[Page/P.135\]](#)

仕様/主材:ホワイトオーク材(ナチュラル) 座:ビニールレザー張  
サイズ/W490xD510xH765xSH430

※ロット20脚の場合の価格です。



◆C-CW-CE-020A-AC

¥84,800 (本体価格) [】\[Page/P.135\]](#)

仕様/主材:ビーチ材(ダークブラウン) 座:布張  
サイズ/W550xD580xH765xSH440xAH655

※ロット20脚の場合の価格です。



◆C-CW-CE-021A-AC

¥84,800 (本体価格) [】\[Page/P.135\]](#)

仕様/主材:ビーチ材(ナチュラル) 座:布張  
サイズ/W550xD580xH765xSH440xAH655

※ロット20脚の場合の価格です。

## RU CHAIR



◆C-CW-CE-010

¥109,500 (本体価格) [】\[Page/P.137\]](#)

仕様/フレーム:オーク材 座:布張  
サイズ/W550xD500xH635xSH415

※ロット20脚の場合の価格です。



◆C-TW-CE-020

¥485,000 (本体価格) [】\[Page/P.137\]](#)

仕様/天板:オーク突板 脚部:オーク材  
サイズ/W1,800xD900xH700



◆C-TW-CE-021

¥472,000 (本体価格) [】\[Page/P.137\]](#)

仕様/天板:オーク突板 脚部:オーク材  
サイズ/W1,500xD900xH700



◆C-TW-CE-022

¥437,000 (本体価格) [】\[Page/P.137\]](#)

仕様/天板:オーク突板 脚部:オーク材  
サイズ/W900xD900xH700

## FRAME



★C-CW-VD-B353-□-01

¥84,500 (本体価格) [】\[Page/P.139\]](#)

仕様/主材:オーク材・アクリル塗装  
サイズ/W490xD500xH760xSH460

[Frame Color variation]  
Oak natural (NAT)、White (LWG)



★C-CW-VD-B353-□-06

¥105,000 (本体価格) [】\[Page/P.139\]](#)

仕様/主材:オーク材・アクリル塗装  
サイズ/W510xD510xH1,000xSH750

[Frame Color variation]  
Oak natural (NAT)、White (LWG)

**★C·CW·VD-B353·□·11**仕様/主材:オーク材・アクリル塗装  
サイズ/W490×D500×H760×SH460

¥75,500 (本体価格)

»[Page/P.139]

[Frame Color variation]  
Oak natural (NAT)、White (LWG)**★C·CW·VD-B353·□·14**仕様/主材:オーク材・アクリル塗装  
サイズ/W720×D570×H670×SH380

¥102,000 (本体価格)

»[Page/P.139]

[Frame Color variation]  
Oak natural (NAT)、White (LWG)**LACLASICA****★C·CW·SA-010**仕様/主材:アッシュ材(ナチュラル) 4脚スタッキング  
サイズ/W530×D500×H820×SH460

¥58,000 (本体価格)

»[Page/P.141]

**★C·CW·SA-011**仕様/主材:アッシュ材(ブラック) 4脚スタッキング  
サイズ/W530×D500×H810×SH450

¥58,000 (本体価格)

»[Page/P.141]

**★C·CW·SA-012**仕様/主材:アッシュ材(ダークブラウン) 4脚スタッキング  
サイズ/W530×D500×H810×SH450

¥55,000 (本体価格)

»[Page/P.141]

**★C·CW·SA-013**仕様/主材:アッシュ材(ホワイト) 4脚スタッキング  
サイズ/W530×D500×H810×SH450

¥55,000 (本体価格)

»[Page/P.141]

**MIXIS****★C·CW·CG-011**仕様/主材:アッシュ材 4脚スタッキング  
サイズ/W540×D650×H800×SH460

¥94,000 (本体価格)

»[Page/P.143]

**★C·CW·CG-012·□**仕様/主材:アッシュ材 4脚スタッキング  
サイズ/W540×D650×H800×SH460

¥82,000 (本体価格)

»[Page/P.143]

[Color variation]  
Light gray (M2)、White (M6)、Green (M7)、Yellow (M9)、  
Light blue (M10)**★C·CW·CG-020·□**仕様/主材:アッシュ材  
サイズ/W490×D460×H650

¥88,000 (本体価格)

»[Page/P.143]

[Color variation]  
Light gray (M2)、White (M6)、Green (M7)、Yellow (M9)、  
Light blue (M10)**MIXIS AIR****★C·CS·CG-B331·□·4L**仕様/シート:ポリプロピレン 脚部:スチール  
サイズ/W510×D580×H800×SH460

¥27,800 (本体価格)

»[Page/P.145]

[Color variation]  
White (PWH)、Black (PBK)、Dark gray (PGY)**★C·CS·CG-B331·□·SB**仕様/シート:ポリプロピレン 脚部:スチール  
サイズ/W510×D580×H800×SH460

¥27,800 (本体価格)

»[Page/P.145]

[Color variation]  
White (PWH)、Black (PBK)、Dark gray (PGY)**★C·CS·CG-B331·□·PB**仕様/シート:ポリプロピレン 脚部:アルミ・粉体塗装  
サイズ/W510×D580×H800×SH460

¥47,800 (本体価格)

»[Page/P.145]

[Color variation]  
White (PWH)、Black (PBK)、Dark gray (PGY)**POLA LIGHT****★C·CS·CG-020·□**仕様/シート:ポリプロピレン 脚部:スチールクロムメッキ 12脚スタッキング  
サイズ/W430×D580×H800×SH460

¥26,000 (本体価格)

»[Page/P.147]

[Color variation]  
White (P1)、Gray (P2)、Dark gray (P3)、Black (P4)、Light blue (P5)、  
Green (P6)、Red (P7)**★C·CS·CG-010·□**仕様/シート:ポリプロピレン 脚部:スチール塗装仕上(シエル同色) 12脚スタッキング  
サイズ/W430×D580×H800×SH460

¥26,000 (本体価格)

»[Page/P.147]

[Color variation]  
White (P1)、Gray (P2)、Dark gray (P3)、Black (P4)、Light blue (P5)、  
Green (P6)、Red (P7)**★C·CS·CG-030**仕様/背座:布張 脚部:スチール塗装仕上  
サイズ/W430×D580×H800×SH460

¥90,000 (本体価格)

»[Page/P.147]

**★C·CS·CG-B329·65·□**仕様/シート:ポリプロピレン 脚部:スチール塗装仕上  
サイズ/W520×D560×H1,000×SH650

¥41,500 (本体価格)

»[Page/P.147]

[Color variation]  
White (P1)、Gray (P2)、Dark gray (P3)、Black (P4)、Light blue (P5)、  
Green (P6)、Red (P7)**★C·CS·CG-B329·73·□**仕様/シート:ポリプロピレン 脚部:スチール塗装仕上  
サイズ/W520×D560×H1,070×SH730

¥43,000 (本体価格)

»[Page/P.147]

[Color variation]  
White (P1)、Gray (P2)、Dark gray (P3)、Black (P4)、Light blue (P5)、  
Green (P6)、Red (P7)**★C·CS·CG-B329·82·□**仕様/シート:ポリプロピレン 脚部:スチール塗装仕上  
サイズ/W520×D560×H1,160×SH820

¥45,500 (本体価格)

»[Page/P.147]

[Color variation]  
White (P1)、Gray (P2)、Dark gray (P3)、Black (P4)、Light blue (P5)、  
Green (P6)、Red (P7)

## NETT



### ★C-CS-CG-B328-□・4L

¥33,000 (本体価格) [》\[Page/P.148\]](#)

仕様/シート: ポリアプロピレン 脚部: スチール・クロムメッキ  
サイズ/W500xD530xH810xSH460

[Color variation]  
White (PWH)、Black (PBK)、Green (PGR)

### ★C-CS-CG-B328-□・SB

¥33,000 (本体価格) [》\[Page/P.148\]](#)

仕様/シート: ポリアプロピレン 脚部: スチール・クロムメッキ  
サイズ/W500xD530xH810xSH460

[Color variation]  
White (PWH)、Black (PBK)、Green (PGR)

## POLA ROUND



### ★C-CS-CG-B330-□・WP

¥72,800 (本体価格) [》\[Page/P.149\]](#)

仕様/シート: ポリアプロピレン 脚部: オーク材・アクリル塗装  
サイズ/W570xD580xH800xSH470

[Color variation]  
White (WH)、Red (RE)、Yellow (YE)、Blue (BU)、Gray (GR)、Black (BK)

### ★C-CS-CG-B330-□・4L

¥35,000 (本体価格) [》\[Page/P.149\]](#)

仕様/シート: ポリアプロピレン 脚部: スチール・クロムメッキ  
サイズ/W570xD580xH800xSH470

[Color variation]  
White (WH)、Red (RE)、Yellow (YE)、Blue (BU)、Gray (GR)、Black (BK)

### ★C-CS-CG-B330-□・SB

¥35,000 (本体価格) [》\[Page/P.149\]](#)

仕様/シート: ポリアプロピレン 脚部: スチール・クロムメッキ  
サイズ/W570xD580xH800xSH470

[Color variation]  
White (WH)、Red (RE)、Yellow (YE)、Blue (BU)、Gray (GR)、Black (BK)

### ★C-CS-CG-B330-□・PB

¥52,000 (本体価格) [》\[Page/P.149\]](#)

仕様/シート: ポリアプロピレン 脚部: アルミ・粉体塗装(ブラック)  
サイズ/W570xD580xH800xSH470

[Color variation]  
White (WH)、Red (RE)、Yellow (YE)、Blue (BU)、Gray (GR)、Black (BK)

## KAY



### ★C-CS-TE-B356-08

¥121,000 (本体価格) [》\[Page/P.151\]](#)

仕様/ビーチ集成材、オーク突板、布張 脚部: アルミ  
サイズ/W540xD620xH760xSH440

### ★C-CS-TE-B356-07 (昇降タイプ)

¥129,000 (本体価格) [》\[Page/P.151\]](#)

仕様/ビーチ集成材、オーク突板、布張 脚部: アルミ  
サイズ/W540xD620xH760-830xSH440-510

## KABIRA



### ★C-CW-AT-B318-□・AC

¥77,800 (本体価格) [》\[Page/P.153\]](#)

仕様/シート: アッシュ材・アクリル塗装 座: 布張 脚部: アッシュ材・アクリル塗装  
サイズ/W580xD560xH740xSH460

[Frame Color variation]  
Natural (T3)、Stained oak (T2)

### ★C-CW-AT-B318-□・ST

¥91,000 (本体価格) [》\[Page/P.153\]](#)

仕様/シート: アッシュ材・アクリル塗装 座: 布張 脚部: アッシュ材・アクリル塗装  
サイズ/W500xD540xH990xSH750

[Frame Color variation]  
Natural (T3)、Stained oak (T2)

### ★C-CS-AT-B318-M7-ST

¥70,000 (本体価格) [》\[Page/P.153\]](#)

仕様/シート: アッシュ材・アクリル塗装(ブラック) 座: 布張 脚部: スチール・粉体塗装(ブラック)  
サイズ/W500x510xH990xSH750

## MÁNI



### ★C-CS-AT-B319-4L

¥21,500 (本体価格) [》\[Page/P.155\]](#)

仕様/シート: ポリアプロピレン 座: 布張 脚部: スチール・粉体塗装(ブラック)  
サイズ/W565xD530xH805xSH450

### ★C-CS-AT-B319-SP

¥56,800 (本体価格) [》\[Page/P.155\]](#)

仕様/シート: ポリアプロピレン 座: 革張 脚部: アルミ(ブラック)  
サイズ/W480xD520xH805xSH450

### ★C-CS-AT-B319-HO

¥50,800 (本体価格) [》\[Page/P.155\]](#)

仕様/シート: ポリアプロピレン 座: 布張 脚部: アルミ(ブラック) キャスター付  
サイズ/W480xD520xH805xSH450

## VERVE



### ★C-CS-FA-B336-3702

¥149,000 (本体価格) [》\[Page/P.157\]](#)

仕様/脚部: スチール・粉体塗装 背座: 布張  
サイズ/W585xD595xH745xSH490

### ★C-CS-FA-B336-3741

¥40,000 (本体価格) [》\[Page/P.157\]](#)

仕様/シート: ポリアプロピレン 脚部: スチール・粉体塗装  
サイズ/W575xD580xH725xSH450

### ★C-CS-FA-B336-3700

¥94,000 (本体価格) [》\[Page/P.157\]](#)

仕様/シート: ポリアプロピレン 脚部: アルミ キャスター付 座パッド: 布張  
サイズ/W575xD575xH755xSH495

### ★C-CS-FA-B336-3732

¥149,000 (本体価格) [》\[Page/P.157\]](#)

仕様/脚部: アルミ 背座: 布張  
サイズ/W585xD585xH755xSH505

### ★C-CS-FA-B336-3722

¥179,000 (本体価格) [》\[Page/P.157\]](#)

仕様/シート: ポリアプロピレン 脚部: スチール・粉体塗装 座パッド: PVCレザー  
サイズ/W575xD580xH745xSH490

# ACME



★C-CS-FA-B335-□-20

¥31,000 (本体価格) [》\[Page/P.159\]](#)

仕様/シート:ポリプロピレン 脚部:スチール・粉体塗装  
サイズ/W505xD500xH800xSH475

[Color variation]  
White (WH), Stone (ST), Electric blue (EB), Powder nude (PN), Black (BK)



★C-CS-FA-B335-□-21

¥47,000 (本体価格) [》\[Page/P.159\]](#)

仕様/シート:ポリプロピレン 脚部:スチール・粉体塗装 座パッド:布張  
サイズ/W505xD500xH800xSH475

[Color variation]  
White (WH), Stone (ST), Electric blue (EB), Powder nude (PN), Black (BK)



★C-CS-FA-B335-□-30

¥45,000 (本体価格) [》\[Page/P.159\]](#)

仕様/シート:ポリプロピレン 脚部:スチール・粉体塗装  
サイズ/W505xD500xH800xSH465

[Color variation]  
White (WH), Stone (ST), Electric blue (EB), Powder nude (PN), Black (BK)



★C-CS-FA-B335-□-31

¥62,000 (本体価格) [》\[Page/P.159\]](#)

仕様/シート:ポリプロピレン 脚部:スチール・粉体塗装 座パッド:布張  
サイズ/W505xD500xH800xSH475

[Color variation]  
White (WH), Stone (ST), Electric blue (EB), Powder nude (PN), Black (BK)



★C-CS-FA-B335-□

¥31,000 (本体価格) [》\[Page/P.159\]](#)

仕様/シート:ポリプロピレン 脚部:スチール・粉体塗装  
サイズ/W510xD490xH805xSH460

[Color variation]  
White (WH), Stone (ST), Electric blue (EB), Powder nude (PN), Black (BK)



★C-CS-FA-B335-□-01

¥47,000 (本体価格) [》\[Page/P.159\]](#)

仕様/シート:ポリプロピレン 脚部:スチール・粉体塗装 座パッド:布張  
サイズ/W510xD490xH805xSH470

[Color variation]  
White (WH), Stone (ST), Electric blue (EB), Powder nude (PN), Black (BK)



★C-CS-FA-B335-□-10

¥45,000 (本体価格) [》\[Page/P.159\]](#)

仕様/シート:ポリプロピレン 脚部:スチール・粉体塗装  
サイズ/W540xD490xH805xSH460

[Color variation]  
White (WH), Stone (ST), Electric blue (EB), Powder nude (PN), Black (BK)



★C-CS-FA-B335-□-11

¥62,000 (本体価格) [》\[Page/P.159\]](#)

仕様/シート:ポリプロピレン 脚部:スチール・粉体塗装 座パッド:布張  
サイズ/W540xD490xH805xSH470

[Color variation]  
White (WH), Stone (ST), Electric blue (EB), Powder nude (PN), Black (BK)

# CILA



♣C-CS-AR-B357-07

¥110,000 (本体価格) [》\[Page/P.161\]](#)

仕様/背座:布張 脚部:オーク材  
サイズ/W605xD550xH835xSH455



♣C-CS-AR-B357-09

¥52,000 (本体価格) [》\[Page/P.161\]](#)

仕様/背座:ポリプロピレン・布張 脚部:アルミ・ラッカー塗装  
サイズ/W605xD550xH830xSH455



♣C-CS-AR-B357-19

¥103,000 (本体価格) [》\[Page/P.161\]](#)

仕様/背座:合成レザー 脚部:アルミ・ラッカー塗装  
サイズ/W575xD550xH835xSH455

# CATIFA 46



♣C-CS-AR-010-□

c1 ¥25,000 (本体価格) c3~c11 ¥29,000 (本体価格) [》\[Page/P.163\]](#)

仕様/シート:ポリプロピレン 脚部:スチール・クロムメッキ 10脚スタッキング  
サイズ/W565xD535xH800xSH450

[Color variation]  
White (C1), Gray (C3), Skyblue (C4), Red (C6), Beige (C7), Blue (C8), Anthracite (C9),  
Brown (C10), Black (C11), Greige (213), Beige (214), Yellow (215), Pink (216), Green (218)



♣C-CS-AR-011-□

c1 ¥28,000 (本体価格) c3~c11 ¥32,000 (本体価格) [》\[Page/P.163\]](#)

仕様/シート:ポリプロピレン 脚部:スチール・クロムメッキ 10脚スタッキング  
サイズ/W560xD510xH800xSH450

[Color variation]  
White (C1), Gray (C3), Skyblue (C4), Red (C6), Beige (C7), Blue (C8), Anthracite (C9),  
Brown (C10), Black (C11), Greige (213), Beige (214), Yellow (215), Pink (216), Green (218)

# SLIM



★C-CS-MJ-B342-TS

¥51,000 (本体価格) [》\[Page/P.165\]](#)

仕様/フレーム:スチール・ピンクゴールドメッキ 背座:布張  
サイズ/W510xD510xH760xSH460



★C-CS-MJ-B342-CU-U64

¥59,500 (本体価格) [》\[Page/P.165\]](#)

仕様/フレーム:ピンクゴールドメッキ 背座:本革張  
サイズ/W510xD510xH760xSH460



★C-CS-MJ-B342-CU-U66

¥59,500 (本体価格) [》\[Page/P.165\]](#)

仕様/フレーム:スチール・塗装仕上げ 背座:本革張  
サイズ/W510xD510xH760xSH460

# MASTER



★C-CS-MJ-B343-S-□

¥75,800 (本体価格) [》\[Page/P.167\]](#)

仕様/フレーム:スチール 背座:アッシュ材・塗装仕上げ (AS) 背座:積層板[ウォールナット突板] (WN)  
サイズ/W400xD480xH760xSH460

[Wood Color variation]  
Solid ash (AS), Solid walnut bark (WN)



★C-CS-MJ-B343-TS

¥42,800 (本体価格) [》\[Page/P.167\]](#)

仕様/フレーム:スチール 背座:布張  
サイズ/W400xD480xH760xSH460



★C-CS-MJ-B343-65-□

¥87,500 (本体価格) [》\[Page/P.167\]](#)

仕様/フレーム:スチール 背座:アッシュ材・塗装仕上げ (AS) 背座:積層板[ウォールナット突板] (WN)  
サイズ/W410xD480xH930xSH660

[Wood Color variation]  
Solid ash (AS), Solid walnut bark (WN)



★C-CS-MJ-B343-75-□

¥87,500 (本体価格) [》\[Page/P.167\]](#)

仕様/フレーム:スチール 背座:アッシュ材・塗装仕上げ (AS) 背座:積層板[ウォールナット突板] (WN)  
サイズ/W410xD480xH1,030xSH760

[Wood Color variation]  
Solid ash (AS), Solid walnut bark (WN)



★C-CS-MJ-B343-65TS

¥71,000 (本体価格) [》\[Page/P.167\]](#)

仕様/フレーム:スチール・ピンクゴールドメッキ 背座:布張  
サイズ/W410xD480xH930xSH660



★C-CS-MJ-B343-75TS

¥78,000 (本体価格) [》\[Page/P.167\]](#)

仕様/フレーム:スチール・ピンクゴールドメッキ 背座:本革張  
サイズ/W410xD480xH1,030xSH760

## A-COLLECTION



### ★C-CW-CL-B326-□-P

仕様/フレーム:スチール シート:オーク成型合板・布張  
サイズ/W400xD500xH750xSH460

¥81,800 (本体価格) >>[Page/P.169]

[Color variation]  
White (1), Black (3)



### ★C-CW-CL-B326-□-R

仕様/フレーム:スチール シート:オーク成型合板  
サイズ/W400xD500xH750xSH460

¥61,000 (本体価格) >>[Page/P.169]

[Color variation]  
White (1), Black (3)



### ★C-CW-CL-B326-□-1P

仕様/フレーム:スチール シート:オーク成型合板・布張  
サイズ/W480xD500xH750xSH460

¥91,000 (本体価格) >>[Page/P.169]

[Color variation]  
White (1), Black (3)



### ★C-CW-CL-B326-□-1R

仕様/フレーム:スチール シート:オーク成型合板  
サイズ/W480xD500xH750xSH460

¥68,800 (本体価格) >>[Page/P.169]

[Color variation]  
White (1), Black (3)



### ★C-CW-CL-B326-□-2P

仕様/フレーム:スチール シート:オーク成型合板・布張  
サイズ/W480xD500xH750xSH460xAH660

¥114,000 (本体価格) >>[Page/P.169]

[Color variation]  
White (1), Black (3)



### ★C-CW-CL-B326-□-2R

仕様/フレーム:スチール シート:オーク成型合板  
サイズ/W480xD500xH750xSH460xAH660

¥74,800 (本体価格) >>[Page/P.169]

[Color variation]  
White (1), Black (3)



### ★C-CW-CL-B326-□-3P

仕様/フレーム:スチール シート:オーク成型合板・布張  
サイズ/W570xD540xH710xSH420

¥98,800 (本体価格) >>[Page/P.169]

[Color variation]  
White (1), Black (3)



### ★C-CW-CL-B326-□-3R

仕様/フレーム:スチール シート:オーク成型合板  
サイズ/W570xD540xH710xSH420

¥74,800 (本体価格) >>[Page/P.169]

[Color variation]  
White (1), Black (3)



### ★C-CW-CL-B326-□-4P

仕様/フレーム:スチール シート:オーク成型合板・布張  
サイズ/W570xD540xH710xSH420xAH610

¥105,000 (本体価格) >>[Page/P.169]

[Color variation]  
White (1), Black (3)



### ★C-CW-CL-B326-□-4R

仕様/フレーム:スチール シート:オーク成型合板  
サイズ/W570xD540xH710xSH420xAH610

¥81,000 (本体価格) >>[Page/P.169]

[Color variation]  
White (1), Black (3)

## GAS



### ★C-CS-SA-080-AC

仕様/フレーム:スチール(ホワイト) 背座:布張 5脚スタッキング  
サイズ/W570xD485xH785xSH445

¥80,000 (本体価格) >>[Page/P.171]



### ★C-CS-SA-081-AC

仕様/フレーム:スチール(ホワイト) 座:エコレザー 背:メッシュ 5脚スタッキング  
サイズ/W570xD485xH785xSH445

¥74,000 (本体価格) >>[Page/P.171]



### ★C-CS-SA-100-AL

仕様/フレーム:スチール(ブラック) 背座:ポリプロピレン(ブラック) 8脚スタッキング  
サイズ/W505xD485xH785xSH445

¥52,000 (本体価格) >>[Page/P.171]



### ★C-CS-SA-111-AC

仕様/フレーム:スチール(ブラック) 背座:エコレザー 5脚スタッキング  
サイズ/W570xD485xH785xSH445xAH640

¥75,000 (本体価格) >>[Page/P.171]



### ★C-CN-SA-070-AC

仕様/フレーム:スチール(ホワイト) 背座:布張  
サイズ/W590xD590xH760-850xSH430-520

¥99,000 (本体価格) >>[Page/P.171]

## GLOBUS



### ★C-CS-SA-050-□

仕様/脚部:スチールクロムメッキ 背座:ポリプロピレン スタッキング6脚  
サイズ/W500xD530xH815xSH450

¥28,000 (本体価格) >>[Page/P.173]

[Color variation]  
White (G1), Pale pink (G2), Stone (G3), Taupe (G4), Brown (G5),  
Green (G6), Orange (G7), Red (G8), Turquoise (G9), Black (G10)

## SAT



### ★C-CG-PT-B357-C2

仕様/本体:ポリエチレン 天板:HPL  
サイズ/W570xD400xH660xSH450

¥42,000 (本体価格) >>[Page/P.175]



### ★C-CG-PT-B357-G9

仕様/本体:ポリエチレン 天板:バーチ  
サイズ/W570xD400xH660xSH450

¥60,800 (本体価格) >>[Page/P.175]

## SIGN



### ★C-CG-MF-B354-FI-□

仕様/本体:スチール・クロムメッキ  
サイズ/W500xD550xH775xSH490

¥261,000 (本体価格) >>[Page/P.177]

[Color variation]  
Black chrome (54), Gold chrome (55), Pink gold chrome (56)



### ★C-CG-MF-B354-MC-□

仕様/本体:ポリエチレン  
サイズ/W480xD515xH745xSH470

¥68,500 (本体価格) >>[Page/P.177]

[Color variation]  
White (05), Cement (36), Mud (50), Navy blue (52), Corten (57)

**★C-CG-MF-B354-MA-□**¥102,000 (本体価格) [» \[Page/P.177\]](#)仕様/本体: ポリエチレン  
サイズ/W720xD710xH620xSH385[Color variation]  
White (05)、Cement (36)、Mud (50)、Navy blue (52)、Corten (57)**★C-CG-MF-B354-BS-□**¥38,500 (本体価格) [» \[Page/P.177\]](#)仕様/本体: ポリエチレン for kids  
サイズ/W380xD445xH585xSH350[Color variation]  
White (07)、Green (33)、Yellow (35)、Orange (30)、Red (29)、  
Light blue (58)、Pink (59)**BT STOOL****◆C-CW-CE-070**¥49,800 (本体価格) [» \[Page/P.179\]](#)仕様/本体: 布張 手掛: 本革  
サイズ/φ450xH440**APELLE JUMP****★C-CS-MJ-B344-45**¥31,800 (本体価格) [» \[Page/P.183\]](#)仕様/脚部: スチール 座: 革張  
サイズ/W420xD420xH470**★C-CS-MJ-B344-65**¥35,800 (本体価格) [» \[Page/P.183\]](#)仕様/脚部: スチール 座: 革張  
サイズ/W440xD410xH660**★C-CS-MJ-B344-75**¥38,800 (本体価格) [» \[Page/P.183\]](#)仕様/脚部: スチール塗装 座: 革張  
サイズ/W420xD400xH760**BARBRY****★C-CS-FA-B337-B**¥86,000 (本体価格) [» \[Page/P.185\]](#)仕様/座面: オーク材 脚部: スチール  
サイズ/φ420xH760**★C-CS-FA-B337-B1**¥98,000 (本体価格) [» \[Page/P.185\]](#)仕様/座面: 布張 脚部: スチール  
サイズ/φ420xH770**JAMAICA STOOL****★C-CS-BD-B323-ML**¥85,800 (本体価格) [» \[Page/P.187\]](#)仕様/脚部: スチール・クロムメッキ 座面: アルミ・ポリッシュ仕上げ  
サイズ/W470xD430xH710**★C-CS-BD-B323-MH**¥87,000 (本体価格) [» \[Page/P.187\]](#)仕様/脚部: スチール・クロムメッキ 座面: アルミ・ポリッシュ仕上げ  
サイズ/W510xD480xH810**★C-CS-BD-B323-WL**¥109,000 (本体価格) [» \[Page/P.187\]](#)仕様/脚部: スチール・クロムメッキ 座面: ビーチ材・塗装仕上げ  
サイズ/W470xD430xH730**★C-CS-BD-B323-WH**¥110,000 (本体価格) [» \[Page/P.187\]](#)仕様/脚部: スチール・クロムメッキ 座面: ビーチ材・塗装仕上げ  
サイズ/W510xD480xH830**ONDA****★C-CS-SA-040**¥33,000 (本体価格) [» \[Page/P.189\]](#)仕様/脚部: スチール・クロムメッキ 座: ポリプロピレン・シリコン  
サイズ/W415xD355xH625xSH460**★C-CS-SA-030**¥38,000 (本体価格) [» \[Page/P.189\]](#)仕様/脚部: スチール・クロムメッキ 座: ポリプロピレン・シリコン  
サイズ/W415xD345xH825xSH660**★C-CS-SA-020**¥51,000 (本体価格) [» \[Page/P.189\]](#)仕様/脚部: ステンレス・マット仕上げ 座: ポリプロピレン  
サイズ/W415xD365xH925xSH760**OBI****★C-CS-VN-B351-DC-□**¥91,000 (本体価格) [» \[Page/P.192\]](#)仕様/フレーム: アルミ粉体塗装・PVCベルト 座クッション: 布張  
サイズ/W550xD550xH750xSH390xAH650[Color variation]  
Charcoal (B1398)、Brown (B133)**★C-SF-VN-B351-AC-□**¥434,000 (本体価格) [» \[Page/P.193\]](#)仕様/フレーム: アルミ粉体塗装・PVCベルト 座クッション: 布張  
サイズ/W1,040xD840xH640xSH400[Color variation]  
Charcoal (B1398)、Brown (B133)**★C-SF-VN-B351-SF-□**¥729,000 (本体価格) [» \[Page/P.193\]](#)仕様/フレーム: アルミ粉体塗装・PVCベルト 座クッション: 布張  
サイズ/W2,280xD840xH640xSH400[Color variation]  
Charcoal (B1398)、Brown (B133)

## BOLD

	★C-SG-PT-B347-□・AC 仕様/本体:ポリエチレン クッション:DRYFEEL サイズ/W850xD780xH770xSH430	¥139,000 (本体価格) <a href="#">»[Page/P.194]</a> [Color variation] White (C2)、Dark brown (N4)
	★C-SG-PT-B347-□・SF 仕様/本体:ポリエチレン クッション:DRYFEEL サイズ/W1,650xD780xH770xSH430	¥243,000 (本体価格) <a href="#">»[Page/P.195]</a> [Color variation] White (C2)、Dark brown (N4)
	★C-TG-PT-B347-□・T 仕様/本体:ポリエチレン 天板:HPL サイズ/W730xD730xH370	¥59,800 (本体価格) <a href="#">»[Page/P.195]</a> [Color variation] White (C2)、Dark brown (N4)

## LAPALA

	★C-CS-EM-B332-□・596 仕様/フレーム:ステンレス ポリエステルロープ サイズ/W700xD680xH730xSH380xAH590	¥195,000 (本体価格) <a href="#">»[Page/P.197]</a> [Color variation] White (100)、Black (101)
	★C-CS-EM-B332-□・590 仕様/フレーム:ステンレス ポリエステルロープ サイズ/W680xD570xH380	¥165,000 (本体価格) <a href="#">»[Page/P.197]</a> [Color variation] White (100)、Black (101)

## CLEVER

	★C-CW-VN-B352・AC7 仕様/フレーム:アルミ 背座:布張(屋外用) サイズ/W580xD560xH780xSH450	¥44,500 (本体価格) <a href="#">»[Page/P.199]</a>
	★C-CW-VN-B352・AC8 仕様/フレーム:アルミ 背座:布張(屋外用) サイズ/W580xD560xH780xSH450	¥44,500 (本体価格) <a href="#">»[Page/P.199]</a>
	★C-CW-VN-B352・AC4 仕様/フレーム:アルミ 背:ロープ編み(屋外用) 座:布張(屋外用) サイズ/W580xD560xH780xSH450	¥46,500 (本体価格) <a href="#">»[Page/P.199]</a>
	★C-CW-VN-B352・AC3 仕様/フレーム:アルミ 背:ロープ編み(屋外用) 座:布張(屋外用) サイズ/W580xD560xH780xSH450	¥46,500 (本体価格) <a href="#">»[Page/P.199]</a>
	★C-CW-VN-B352・AC1 仕様/フレーム:アルミ 背座:布張(屋外用) サイズ/W580xD560xH780xSH450	¥41,800 (本体価格) <a href="#">»[Page/P.199]</a>
	★C-CW-VN-B352・AC2 仕様/フレーム:アルミ 背座:布張(屋外用) サイズ/W580xD560xH780xSH450	¥41,800 (本体価格) <a href="#">»[Page/P.199]</a>
	★C-CW-VN-B352・AC5 仕様/フレーム:アルミ 背座:布張(屋外用) サイズ/W580xD560xH780xSH450	¥44,500 (本体価格) <a href="#">»[Page/P.199]</a>
	★C-CW-VN-B352・AC6 仕様/フレーム:アルミ 背座:布張(屋外用) サイズ/W580xD560xH780xSH450	¥44,500 (本体価格) <a href="#">»[Page/P.199]</a>

## LEAF

	♣C-CG-AR-010-□ 仕様/フレーム:スチール サイズ/W860xD645xH705xSH435	¥84,000 (本体価格) <a href="#">»[Page/P.201]</a> [Color variation] White (L1)、Green (L2)、Dark brown (L3)
	♣C-CG-AR-020-KC-□ (010用座クッション) 仕様/主材:ポリウレタン サイズ/W460xD460	¥17,000 (本体価格) <a href="#">»[Page/P.201]</a> [Color variation] White (L1)、Green (L2)、Dark brown (L3)
	♣C-CG-AR-030-□ 仕様/フレーム:スチール サイズ/W520xD545xH830xSH450	¥45,000 (本体価格) <a href="#">»[Page/P.201]</a> [Color variation] White (L1)、Green (L2)、Dark brown (L3)
	♣C-CG-AR-040-KC-□ (030用座クッション) 仕様/主材:ポリウレタン サイズ/W430xD430	¥13,000 (本体価格) <a href="#">»[Page/P.201]</a> [Color variation] White (L1)、Green (L2)、Dark brown (L3)
	♣C-TG-AR-050T 仕様/天板:メラミン化粧版 脚部:スチール(ダークブラウン) サイズ/φ790xH740	¥72,000 (本体価格) <a href="#">»[Page/P.203]</a>
	♣C-TG-AR-060T 仕様/天板:メラミン化粧版 脚部:スチール(ダークブラウン) サイズ/φ1,000xH740	¥119,000 (本体価格) <a href="#">»[Page/P.203]</a>
	♣C-TG-AR-070T 仕様/天板:メラミン化粧版 脚部:スチール(ダークブラウン) サイズ/W790xD790xH740	¥84,000 (本体価格) <a href="#">»[Page/P.203]</a>





♣C・CG-AR-110・AL・□

仕様/主材:ポリプロピレン 4脚スタッキング  
サイズ/W485×D545×H780×SH460

¥20,000 (本体価格) »[Page/P.205]

[Color variation]  
White (J1)、Yellow (J2)、Orange (J3)、Beige (J4)、Black (J5)



♣C・CG-AR-130・AC・□

仕様/主材:ポリプロピレン 4脚スタッキング  
サイズ/W550×D545×H780×SH460

¥25,000 (本体価格) »[Page/P.205]

[Color variation]  
White (J1)、Yellow (J2)、Orange (J3)、Beige (J4)、Black (J5)



♣C・CG-AR-120・AL・□

仕様/主材:ポリプロピレン 4脚スタッキング  
サイズ/W485×D545×H780×SH460

¥21,000 (本体価格) »[Page/P.205]

[Color variation]  
White (J1)、Yellow (J2)、Orange (J3)、Beige (J4)、Black (J5)



♣C・CG-AR-140・AC・□

仕様/主材:ポリプロピレン 4脚スタッキング  
サイズ/W550×D545×H780×SH460

¥26,000 (本体価格) »[Page/P.205]

[Color variation]  
White (J1)、Yellow (J2)、Orange (J3)、Beige (J4)、Black (J5)

## Creare 製品について

■カタログ記載の価格表示について

本カタログでは全て税抜価格を表記しています。消費税を別途承ります。

■掲載製品価格について

本カタログ掲載の製品は2018年2月1日現在のものです。物価の変動、品質の改善等により価格・寸法・仕様・カラー等は予告なく変更させていただく場合があります。ご了承ください。

■製品詳細

スペースの都合により、一部製品の詳しい説明を省略している場合があります。詳細は担当者までお問い合わせください。

■寸法誤差について

表示寸法は製造ロットや張材の厚みなどにより、若干の誤差が生じることがあります。ご了承ください。

■印刷の色調

製品の色彩は印刷上現品と誤差を生じることがあります。ご了承ください。

■納期

輸入品や受注生産品など、納期がかかる場合があります。ご用意の場合は担当者までお問い合わせください。

■輸送費について

このカタログに掲載されている全ての製品は輸送費を除いた価格です。物流条件により価格が変動しますので、お見積りの際は都度お問い合わせください。

■発注後のキャンセルについて

お客様のご都合による発注後のキャンセルにつきましては製作実費をご請求させていただくことがあります。

■配送、搬入について

納入場所、条件を打合わせの上で、別途見積にて対応いたします。

■製品の安全性と保証期間

〈オフィス以外で使用される製品について〉

1年の保証期間を設定しております。

このカタログに掲載されている製品の中で、オフィス家具に該当しない製品（業務用及び家庭用家具）は、取扱説明書に従った正しい使用状態の場合に限り、1年の保証期間を設定しております。（「JOIFA」の定めた保証期間と異なります。）

※ ガーデン等の屋外で使用する製品につきましては、

保証期間が対象外となる場合がありますのでご了承ください。

※ より良い製品をお届けできるよう細心の注意を払って検査をしておりますが、木や革などの天然素材が使用されている製品は、材質が均一で無いため、仕上がりや耐久性にバラツキが生じます。

また、天然木材は、室内環境の影響により膨潤、収縮し割れや反りが発生することがあります。材の含水率管理を徹底し製造を行っていますが、木は自然素材のため個体差があり完全に防止することはできません。

その際は通常の保証をいたしかねる場合もありますので、ご了承ください。

〈オフィスで使用される製品について〉

当社は社団法人日本オフィス家具協会（通称JOIFA）の「製造物責任に対する基本的考え方」に準拠した安全な製品づくりをモットーとしています。

また、保証期間については特別に定めのある製品以外は、JOIFA顧客対応ガイドラインに基づき、通常の状態で使用された場合、3種別ごとにTEL（お客様ご購入の日から）1年・2年・3年と保証期間を設定しています。

【JOIFA オフィス家具の保証例】

外装・表面仕上げ	塗装および樹脂部品の変・退色、レザークロスの磨耗	> 1年
機構部・可動部	引き出し・スライド機構・扉の開閉・錠前・昇降機構等の故障	> 2年
構造体	強度・構造体にかかる破損	> 3年

# Creare

Produced by Oliver

## Head quarters & Show Room

/ Tokyo Headquarters

6-27-19 Nishi-Kasai, Edogawa Ward, Tokyo, 134-0088  
TEL (03) 5674-9500 FAX (03) 5674-9520

/ Okazaki Headquarters

1-1-12 Yabuta, Okazaki City, Aichi, 444-2137  
TEL (0564) 27-2800 FAX (0564) 27-2860

## Show Room

SAPPORO TEL (011) 350-6870 FAX (011) 350-6855  
SENDAI TEL (022) 745-0950 FAX (022) 745-0951  
NAGOYA TEL (052) 209-6880 FAX (052) 209-6881  
OSAKA TEL (06) 6228-9230 FAX (06) 6228-9240  
FUKUOKA TEL (092) 473-8030 FAX (092) 473-8027



oliver